

Analysis on
Gross Tonnage and Propulsion Power ceilings

ASD Ship Design B.V.
Arie Aalbers
November 2018

Joint action of the European social partners of the sea-fishing sector

Grant agreement No VP/2016/001/0047

This project has been funded with support from the European Union
This publication reflects the views only of the author, and the Union cannot be held responsible
for any use which may be made of the information contained therein.



Table of Contents

SUMMARY AND CONCLUSION	4
ON GROSS TONNAGE.....	4
ON KILOWATTS.....	4
ON ALTERNATIVE FORMULATIONS OF FISHING CAPACITY.....	4
1 BACKGROUND, PURPOSE AND APPROACH	5
2 DEFINITION OF FISHING CAPACITY IN EU LEGISLATION	7
3 WHAT IS GROSS TONNAGE?	8
3.1 DEFINITION OF GROSS TONNAGE.....	8
3.2 GT CALCULATION.....	9
4 GROSS TONNAGE AND KW'S IN EU REGULATIONS	10
4.1 CHARACTERISTICS OF FISHING VESSELS.....	10
5 OTHER MEANS TO DEFINE FISHING CAPACITY	12
5.1 ACCESS REQUIREMENTS APPLICABLE TO FISHING FOR DEEP-SEA STOCKS.....	12
5.2 EC 1966/2006 ELECTRONIC RECORDING AND REPORTING OF FISHING ACTIVITIES AND ON MEANS OF REMOTE SENSING.....	12
6 CONCERNS ON SAFETY IN RELATION TO GROSS TONNAGE	13
6.1 FISHING VESSEL SAFETY GENERAL.....	13
6.2 POLICY AND SAFETY IN FAO STUDY.....	13
6.3 FRENCH STUDY ON SAFETY AND GROSS TONNAGE.....	14
6.4 CONCERNS IN IMO ON GROSS TONNAGE.....	15
6.5 CONCERNS IN ILO ON GROSS TONNAGE.....	16
6.6 CONCERNS IN AMRIE ON GROSS TONNAGE.....	17
6.7 CONCERNS IN EU ON GROSS TONNAGE.....	17
7 SAFETY FRAMEWORK FOR FISHING	18
7.1 INTERNATIONAL AGREEMENTS ON SAFETY IN FISHING.....	18
7.2 EU MEASURES FOR SAFETY AND HEALTH FOR FISHING VESSELS.....	18
7.2.1 <i>General</i>	18
8 IMPACT OF GT RESTRICTIONS ON SAFETY, COMFORT AND ECONOMY	20
8.1 GENERAL.....	20
8.2 PRESSURE ON SAFETY THROUGH GT LIMITATIONS.....	20
8.3 PRESSURE ON CREW COMFORT THROUGH GT LIMITATIONS.....	21
8.4 PRESSURE ON ECONOMY THROUGH GT LIMITATIONS.....	22
8.5 PRESSURE ON SAFETY THROUGH KW LIMITATIONS.....	23
9 KILOWATTS NOT AN ADEQUATE PARAMETER FOR FISHING CAPACITY	24
9.1 GENERAL.....	24
9.2 DEFINITION OF ENGINE POWER.....	24
9.3 TYPES OF PROPULSOR.....	25
9.4 PULLING FORCE OF TRAWLERS.....	26
9.5 CONCLUSION ON ADEQUACY OF KW AS A PREDICTION OF PULLING POWER.....	28
9.6 THE PELAGIC NET.....	29
9.6.1 <i>General</i>	29
9.6.2 <i>Net resistance</i>	29
9.7 CONCLUSION ON KW AND NETS.....	32
10 THEORETICAL FISHING CAPACITY OF A TRAWLER	33
10.1 GENERAL.....	33
10.2 PREVIOUS INVESTIGATIONS.....	35
10.3 OPERATIONAL PROFILE.....	35
10.3.1 <i>Harbour</i>	35
10.3.2 <i>Sailing to fishing area</i>	36
10.3.3 <i>Sailing and cooling down</i>	36
10.3.4 <i>Searching for fish</i>	36
10.3.5 <i>Setting the net</i>	36

10.3.6	<i>Fishing</i>	36
10.3.7	<i>Hauling of the net</i>	37
10.3.8	<i>Pumping</i>	37
10.3.9	<i>Pump handling</i>	37
10.3.10	<i>Freezing while floating</i>	37
10.3.11	<i>Sailing back</i>	37
10.3.12	<i>Manoeuvring</i>	37
10.4	FISHING CAPACITY	38
11	PROPOSAL FOR ALTERNATIVE FORMULATION FISHING CAPACITY	39
11.1	EU STATUS QUO.....	39
11.2	FAO TWG.....	40
11.3	ICELAND.....	41
11.4	NORWAY	41
11.5	ELECTRONIC RECORDING AND REPORTING OF FISHING ACTIVITIES.....	41
12	SUMMARY AND CONCLUSION.....	42
12.1	ON GROSS TONNAGE	42
12.2	ON KILOWATTS	42
12.3	ON ALTERNATIVE FORMULATIONS OF FISHING CAPACITY.....	42

Summary and conclusion

On Gross Tonnage

Gross Tonnage limitation has a negative impact on safety, comfort and fish quality as it punishes initiatives to add extra safety, comfort and quality measures to ships as the involved extra cubic meters have to compete with e.g. hold volume, volume of engine room or fuel tanks.

On kiloWatts

Kilowatt limitation has a very weak rationale as:

- a. Very large variations can occur in the pulling power per kilowatt due to the specific design of up to 40%
- b. Very large variations can occur in the requested pulling power of nets due to the choice of twine materials and trawl doors of more than 50% for the same opening circumference
- c. Which means that a difference in kW can exist of close to 100% between two ships: one with a simple propeller and a conventional net and one with advanced twin propeller and advanced dynema net with high lift trawl doors
- d. Certain fishing metiers do not use the available power to even *avoid* large catches in one haul for quality reasons
- e. Certain fishing metiers do not use the available power to fish, but for safe and fast trips to the fishing area

On alternative formulations of fishing capacity

Alternative formulations to define the size of a ship are:

- a. In the first place: fishing capacity can only be limited by maintaining and controlling the TAC
- b. Other means than the detrimental GT to get an impression of the size of a ship, some possibilities are:
 - i. gross tonnage based on the product of LxBxT: length x beam x draught, this leaves room for sufficient depth and superstructures (e.g. accommodation and forecastle)
 - ii. gross tonnage based on displacement, this also leaves free the superstructures
- f. However, it should be warned that experience with tonnage and/or size limitations learns, that sooner or later again un-natural, mostly unsafer and less comfortable ships will appear

1 Background, purpose and approach

Background¹

The regulatory context: (R n°1380/2013, Article 22, paragraph 7) “Member States shall seek to achieve a stable and enduring balance between the fishing capacity of their fleet and their fishing opportunities. To this end, Member States must ensure that the fishing capacity of their fleet does not exceed the ceilings given in Annex II of the regulation.”

Annex II of the regulation sets, for each Member State, fishing capacity ceilings in terms of Gross tonnage (volume) and in terms of kW (vessel engine propulsion power) of its fishing fleet.

In the merchant navy, historically, the volume of a vessel has always represented the measurement of its capacity. As a result, all the Member States had a tonnage register for vessels including, generally speaking, the tonnage of fishing vessels.

And since it was the only indicator available, European deciders chose it in the '80's, as an indicator to define the fishing capacity of the fishing fleet.

Even though there may be a direct link between the propulsion power and a vessel's fishing capacity, propulsion power is strongly related to fishing vessel safety, especially in bad weather conditions.

There is no direct link between gross tonnage and a vessel's catching capacity. Decent working and living conditions rely on available gross tonnage and propulsion power.

Regardless of the vessel size, the effect of volume ceilings (GT) is to block the adaptation of the vessels to the discard ban rule and to obstruct any measure to enhance crew safety and comfort. The discard ban rule will lead to more unwanted catches to be stored on board or processed on board. Likewise, the evolution to covered-deck vessels to enhance crew safety and protection is hindered by the tonnage ceiling.

The evolution to more crew comfort (accommodation on board, cabins for 2 instead of 4, or 6, etc.) is hindered by the volume ceiling on vessels. However, this evolution is a reality, reinforced by the Work in Fishing Convention C188) being transposed into EU law.

Concretely, the impact of the ceiling of gross tonnage and the discard ban rule means: building, for unchanged volume, a vessel with a smaller storage capacity.

Assuming unchanged catch, the vessel will need to make more journeys between the fishing grounds and unloading ports and back to the fishing grounds, using more fuel, increasing the carbon footprint. More time lost in travel.

European social partners of the sea fishing sector believe that an increase in volume should be justified for the improvement of working and living conditions and fishing vessel safety.

The latter for instance in relation to the discard ban in order to avoid stability problems because fish is stored in unsafe places because of the ban.

¹ Detailed programme of the request for co-financing NoVP/2016/001/0047; Brussels 28th June 2016.

Purpose

The purpose of this study is to investigate the impact of the Gross Tonnage and propulsion power ceilings on working and living conditions, fishing vessel safety and productivity of the enterprises.

Further to generate suggestions for alternatives to the GT and propulsion power to express fishing capacity and to provide arguments to make the EU legislation advance.

Approach

The following approach is chosen:

- i. Investigate EU regulations for fishing vessels on GT and Power
- ii. Judge relevant benchmark vessels on GT and kW aspects
- iii. Identify impact on safety, comfort and economy
- iv. Develop simple operational profile to investigate economic impact
- v. Develop proposals for alternative formulation of fishing capacity

2 Definition of fishing capacity in EU legislation

The 'fishing capacity' of a vessel is defined in the Common Fisheries Policies CFP ² in statement (24) as follows:

'fishing capacity' means a vessel's tonnage in GT (Gross Tonnage) and its power in kW (Kilowatt) as defined in Articles 4 and 5 of Council Regulation (EEC) No 2930/86 (2);

Then in statement (43):

“Member States should take specific measures to align the number of Union fishing vessels with available resources, based on their assessments of the balance between the fishing capacity of their fleets and the fishing opportunities available to them. The assessments should be made in accordance with Commission guidelines and be presented in an annual report to be transmitted to the Commission. Those reports should be made public. Each Member State should be able to choose the measures and instruments which it wishes to adopt in order to reduce excessive fishing capacity”

This leaves room for other measures to reduce excessive fishing capacity then through reduction of Gross Tonnage.

In the same document, however it is mentioned in statement (15):

“The Common Fisheries Policies *should contribute to the improvement of safety and working conditions* for fishing operators.”

This in short reflects the core of this project:

- a. The Gross Tonnage and kW does not represent the fishing capacity of a vessel
- b. The limitation by law of restriction of the Gross Tonnage is detrimental for safety and comfort for the fishermen

² Regulation (EU) No 1380/2013 of the European Parliament and of the Council of 11 December 2013 on the Common Fisheries Policy, amending Council Regulations (EC) No 1954/2003 and (EC) No 1224/2009 and repealing Council Regulations (EC) No 2371/2002 and (EC) No 639/2004 and Council Decision 2004/585/EC

3 What is Gross Tonnage?

3.1 Definition of Gross Tonnage

Gross tonnage is defined in the 1969 Tonnage Regulation as³:

$$GT = (0.2 + 0.02 \log V) \times V$$

Where:

V = the total volume in m³ of all enclosed spaces of a ship.

For smaller ships as a rule of thumb the expression $GT = 0.27 \times V$ and for larger ships $GT = 0.286 \times V$ can be used.

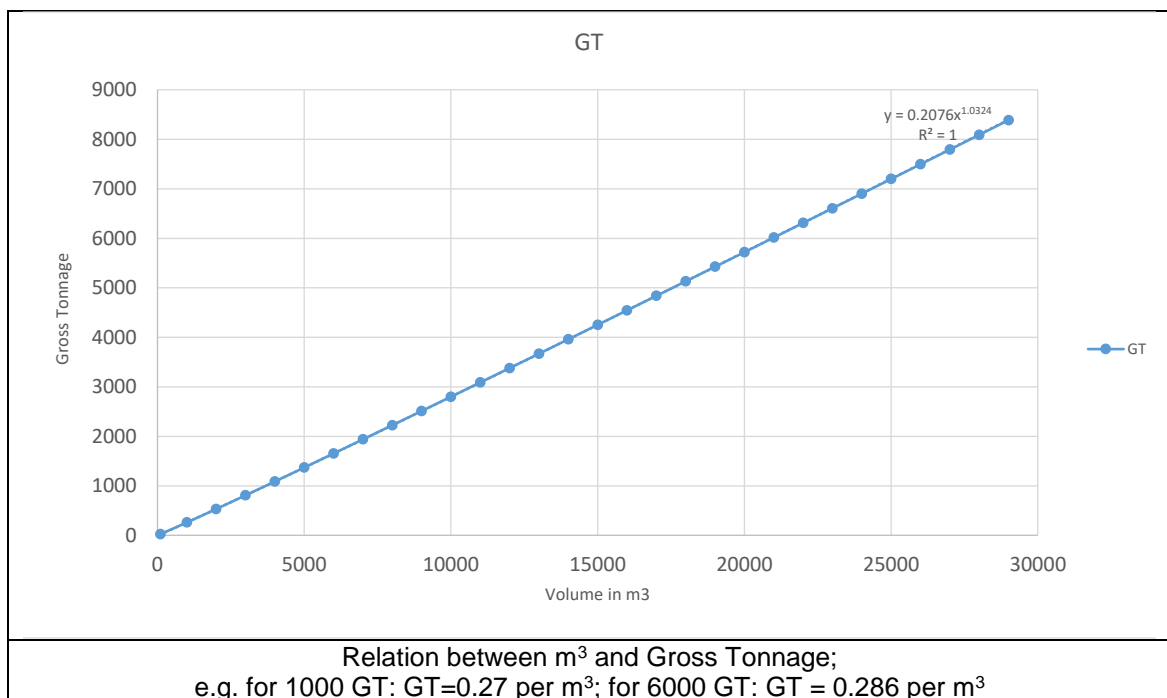

³ International Convention on Tonnage Measurement of Ships, London 1969

3.2 GT calculation

An example is given of the calculation of the Gross Tonnage of a trawler. All enclosed volumes have to be taken into account.

Also the contribution of the various functions on board is given. This shows that e.g. the fish tanks and holds are contributing to not more than 39% of the total GT. The fish sorting and freezing installations, responsible for the quality of the fish, counts for 12 % and the complete accommodation for 13%.

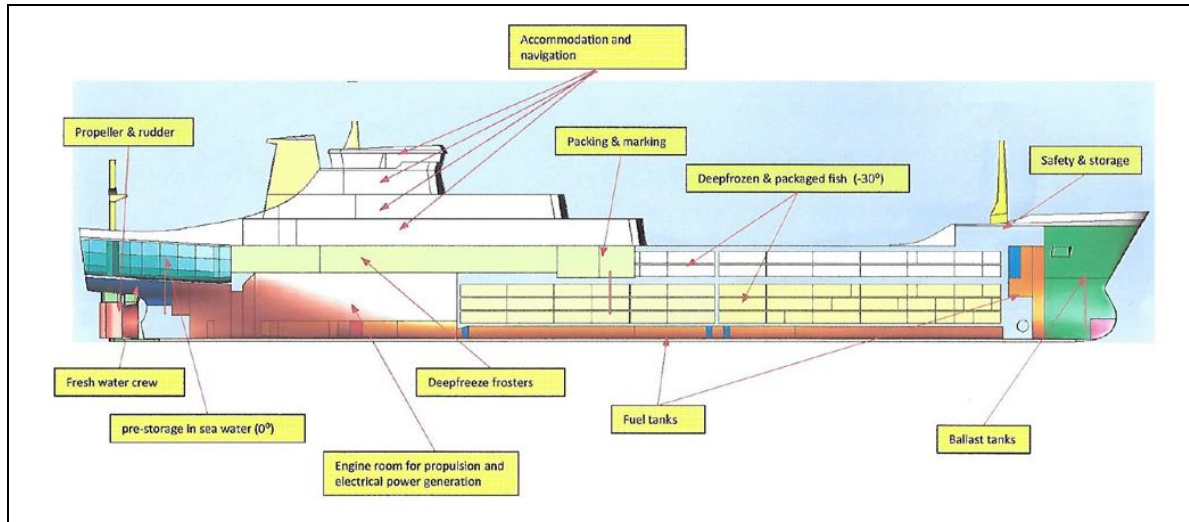

	m3	GT	%
accommodation	1120		
	1176		
	695		
	358		
total accommodation	3349	906	13
factorydeck upper	832		
factorydeck lower	1792		
packing room	432		
total freezing and sorting	3056	824	12
cargohold nett	9140		
RSW	749		
total holds	9889	2768	39
waterballast	540		
HFO	1555		
MDO	358		
engineers tanks	157		
Fresh water	114		
total tanks	2724	732	10
Engine room, rest	5490	1509	21
Total ship	24508	7053	100

Example GT calculation. Showing that RSW tanks and cargo hold contributes for 39% to the total GT

4 Gross Tonnage and kW's in EU regulations

4.1 Characteristics of fishing vessels

Definitions⁴

The characteristics of fishing vessels are defined according Council Regulation (EEC) No 2930/86 of 22 September 1986 defining characteristics for fishing vessels. With reference to the Torremolinos Convention and the International Convention on Tonnage Measurement of Ships 1969. But amended for fishing vessels of less than 15 meters, in Regulation (EU) 2017/1130 of 14th June 2017.⁵⁶

“Whereas the Torremolinos International Convention for the Safety of Fishing Vessels (1977), drawn up under the aegis of the International Maritime Organization (IMO), has already been ratified by several Member States and should be ratified by the others, according to recommendation 80/907/EEC; Whereas the International Convention on Tonnage Measurement of Ships, drawn up in London in 1969 under the aegis of the said organization, has already been ratified by all Member States except for the Grand Duchy of Luxembourg and the Portuguese Republic ; Whereas the International Organization for Standardization has drawn up standards on internal combustion engines which are already widely applied in Member States.”

Length

“1. The length of a vessel shall be the length overall, defined as the distance in a straight line between the foremost point of the bow and the aftermost point of the stern . For the purposes of this definition : (a) the bow shall be taken to include the watertight hull structure, forecastle, stem and forward bulwark, if fitted, but shall exclude bowsprits and safety rails ; (b) the stern shall be taken to include the watertight hull structure, transom, poop, trawl ramp and bulwark, but shall exclude safety rails, bumkins, propulsion machinery, rudders and steering gear, and divers' ladders and platforms. The length overall shall be measured in meters with an accuracy of two decimals.

2. When the length between perpendiculars is mentioned in Community legislation, it shall be defined as the distance measured between the forward and the after perpendiculars as defined by the International Convention for the Safety of Fishing Vessels. The length between perpendiculars shall be measured in meters with an accuracy of two decimals.”

“Tonnage

1 . The tonnage of a vessel shall be gross tonnage as specified in Annex I to the International Convention on Tonnage Measurement of Ships.

2. When net tonnage is mentioned in Community rules it shall be defined as specified in the said Annex I. “

“Engine power

1 . The engine power shall be the total of the maximum continuous power which can be obtained at the flywheel of each engine and which can, by mechanical, electrical, hydraulic or other means, be applied to vessel propulsion. However, where a gearbox is incorporated into the engine, the power shall be measured at the gearbox output flange. No deduction shall be made in respect of auxiliary machines driven by the engine. The unit in which engine power is expressed shall be the kilowatt (KW).

⁴ Council Regulation (EEC) No 2930/86 of 22 September 1986 defining characteristics for fishing vessels (OJ L 274, 25.9.1986).

⁵ Regulation EU 2017/1130 of 14 June 2017 defining characteristics for fishing vessels (recast).

⁶ New fishing vessels with Loa of less than 15 meters is defined as $GT = K1 V$, where $K1 = 0.2 + 0.02 \log V$ and $V = a1 (Loa B T)$ where Loa = length over all, B = breadth according 1969 Convention, T = depth according 1969 Convention. a1 is a function fixed on basis of statistical analyses of pooled representative samples of the fleets of the Member States.

2. The continuous engine power shall be determined in accordance with the requirements adopted by the International Organization for Standardization in its recommended International Standard ISO 3046/1, 2nd edition, October 1981 .

3 . The amendments necessary for adapting the requirements provided for in paragraph 2 to technical progress shall be adopted in accordance with the procedure provided for in Article 14 of Regulation (EEC) No 170/83 (').”

5 Other means to define fishing capacity

5.1 Access requirements applicable to fishing for deep-sea stocks⁷

In the EU publication 2347/2002 the following is listed to define fishing capacity.

Definitions

deep-sea species

deep-sea fishing permit

power; means total installed engine power in kilowatt

volume: means gross tonnage

kilowatt-fishing days: the product of the power and the number of days in which a fishing vessel has any item of fishing gear deployed in the water

Vessel monitoring system: satellite tracking device

Designated ports

Observers

Information concerning fishing gear

For vessels using long-lines:

- the average number of hooks used on the long-lines,
- the total time the lines have been in the sea in any 24-hour period and the number of shots in this period,
- fishing depths.

For vessels using fixed nets:

- the mesh size used in the nets,
- the average length of the nets,
- the average height of the nets,
- the total time the nets have been in the sea in a 24-hour period and the total number of hauls in this time,
- fishing depths.

For vessels using towed gear:

- the size of the mesh used in the nets,
- the total time the nets have been in the sea in a 24-hour period and the total number of hauls in this time
- Fishing depths

5.2 EC 1966/2006 electronic recording and reporting of fishing activities and on means of remote sensing

In this E document room is created for the application of remote sensing as an alternative way of controlling fishing.

⁷ Council Regulation (EU) No 2347/2002 establishing specific assess requirements and associated conditions applicable to fishing for deep-sea stocks

6 Concerns on safety in relation to Gross Tonnage

6.1 Fishing vessel safety general

Fishing is considered as one of the world's most dangerous occupations.⁸ Worldwide the number of fatalities is estimated at 80 per 100000 fishers per year, which means in total 24000 fatalities worldwide per year.⁹

6.2 Policy and safety in FAO study

The negative effect between policy measures and safety in fishing has been elaborated in an FAO study.¹⁰¹¹ From which we cite: Commercial fishing has always been a dangerous occupation. It is inherently dangerous, many argue that the degree of danger is a function of fishers' choices about the risk they take, such as the weather they fish in, the boat they use, the rest they obtain, and the safety gear they carry. Multiple studies suggest that although fisheries management policies are not meant to regulate safety at sea, they do sometimes contribute to safety problems.

The study contained three hypotheses:

Hypothesis 1. Fisheries management policies have wide-ranging indirect effects on fishing safety. Although fisheries management policies are enacted primarily to achieve resource management and social and economic goals, they may affect fishing safety indirectly by affecting fishers' options (how, when and where they may fish), creating incentives for fishers to make risky choices.

This was elaborated in ten case studies. From a report made in the EU the following is derived¹²:

"Another report from the European Union discussed the safety effects of restrictions on the gross tonnage of fleets. Member States are obligated to reduce fishing capacity as measured by gross tonnage and engine power. The authors argue that gross tonnage restrictions have important negative impacts on safety owing to the ageing fleet and restrictions on new vessel construction. The physical characteristics of older vessels may make it almost impossible to install technological advances that protect workers, and constraints placed on new vessel construction do not allow modern construction methods to be used. Similarly, the Spanish authors suggest that the vessel size limits imposed by the European Union result in vessels carrying equipment that makes them unstable in bad weather."

Hypothesis 2: Quota-based fishery management systems are safer than competitive fishery management systems.

In competitive fishery management systems, fishers compete with one another for the available fish. In quota-based fishery management systems, managers limit how much individual fishers may catch. Under the latter, fishers may have less incentive to take risks such as fishing without adequate rest or fishing in bad weather. Quota-based fishery management may also result in the use of newer, safer vessels and gear, and more professional and better-trained crew.

Hypothesis 3: Fisheries management policies that are unsuccessful in protecting resources or limiting the numbers of fishers competing for limited resources may affect safety.

If the resources are not managed well, fishers are faced with trade-offs between

⁸ Safety and health in the fishing industry. ILO, Geneva 1999.

⁹ FAO, Knapp, G, International commercial fishing management regime safety study: synthesis of case reports

¹⁰ FAO, The state of world fisheries and aquaculture 2012

¹¹ Also FAO, Knapp, 2016

¹² Renault, C., Douliazel, F. & Pinon, H. Incidence of gross tonnage limitations under the European Common Fisheries Policy. June 2008.

safety and the income they can earn from fishing. Fishers may venture farther offshore and take greater risks. Similarly, if total catches are limited, more fishers participating in a fishery will result in less opportunity for each fisher to earn income. If the number of fishers competing for resources is not limited, then fishers' average incomes may decline, causing them to take greater risks.

Hypothesis 4: Fisheries management can contribute to safer fisheries directly by integrating safety policies with fishery management policies. Fisheries management agencies may require safety equipment, safety training, and/or inspections as a condition for participating in a given fishery. Fisheries developed in remote locations or identified as being particularly hazardous could have additional requirements placed on participants

6.3 French study on safety and gross tonnage

Cited from Renault, Douliazel and Pinon in the summary of Knapp, the following influence of GT on safety is reported:

“Ageing of the fleet. “... The average age of the fishing fleet steadily increased from 15.4 years in 1991 to 24 years in 2008, which represents an average increase of six months each year. A similar trend was observed in all Europe, to a slightly lesser degree in some countries, but worrying anyway. This ageing phenomenon has a detrimental impact on safety, and on productivity as well. The desirable fleet renewal did not occur, despite the different decommissioning plans and the new constructions in too limited numbers. In the absence of new vessels in sufficient numbers, existing ones are transformed. Elderly ships are kept in operation, while in general they do not provide seafarers with the improvements in occupational safety and working conditions that should result from the technological evolution achieved since the time of their construction ... The mechanical impact of ageing on safety and fuel consumption is straightforward and demonstrated. Ships get heavier, as a result of the progressive accumulation of extra fishing gear, spare parts, paint layers, water absorption in insulating materials and other, usually leading to a 10 to 15% increase in displacement for a ship of a 15 years age, even in the absence of any significant transformation. This increased heaviness modifies the initial stability and load lines data ...” (p. 5)”

“Restrictions on new vessel construction. “New constructions are scarce. Furthermore, as they are subject to numerous and complex constraints, they cannot take full advantage of the potential improvements that could be expected from recent and modern constructions. According to all statements from fishing vessel designers or builders, and from their customers ship-owners and fishermen, it has become extremely difficult to build a ship in accordance with all ship safety and occupational safety and health requirements, because the design and construction of adequate vessels are burdened with quite a set of constraints, and particularly with the gross tonnage limitation ... The constraints originated from the resource protection policies, and specifically the gross tonnage limitation, have a particularly detrimental impact on occupational health and safety, specifically through the resulting restricted space devoted to the crew for their work and daily life.” (p. 6).”

“When designing a new ship, its promoter and the shipyard which receives his order are obsessed by one concern: they have the compelling obligation to contain their project within the limit of the tonnage amount they are authorized to use. However, it is quite obvious **that pursuing a minimum tonnage objective is contrary to ship safety**, having in mind that a minimized tonnage has, among others, the following consequences:

- reduced freeboard,
- reduced enclosed volumes in the upper parts,
- reduced living and working space, detrimental to living and working conditions,
- restricted potential for possible future adaptation to new resource conditions.” (p. 7).

The authors argue that the negative safety effects of the European Union (Member Organization) restrictions are particularly inappropriate because **the restrictions are not effective** in controlling fishing effort:

“The fishing effort control that the confinement of national fishing fleets within a limited overall envelope is supposed to achieve is illusive, and purely formalistic ... The gross tonnage constraints that hamper the quality and safety of the new ships appear to have no relevance with regard to their object.” (p. 8).

A further study on fishing vessel safety was performed in the French ‘Ergospace’ project¹³. It is argued that it is very likely that accidents on board fishing vessels correlate to the size and available space depending on manning, fishing gear, amount of processed catches, working positions etc. In the study the following remarks are made concerning the Gross Tonnage.

“Tonnage is a volume measurement of ships that, mainly in merchant marine, is used to determine different taxes (port taxes, pilotage taxes), insurance rates, required competence certificates for officers. It was never intended for assessing a fishing capacity, which naturally leads to question its relevance and therefore, the interest of limiting it in order to protect fish resources. It is reminded that this relevance was questioned in the reports on MAGPs made by France and the European Commission in the early 2000s. Both concluded that the strict fleet control through tonnage and power did not result in a significant decrease of the fishing capacity, due to the simultaneous technological progress. So, why should the overall tonnage limitation be kept?”

“For ships more than 15 m long, the fishing vessel tonnage calculation mode is defined by the 1969 London Convention for merchant vessels of a more than 24 m length. This method is quite accurate.” “To take one example, on board a trawler the volume of the fishing deck below the upper deck is considered as enclosed if the distance between the gantry legs is less than 90% of the ship’s beam at this section, or open in the opposite case.. It is acceptable that this method is used for measuring the gross tonnage of a fishing vessel as such. However, it seems absurd this result to be used for measuring its fishing capacity: which can be the relationship between the fishing capacity and the distance between the gantry legs?”

“Taking into account of its detrimental effect on safety and working/living conditions, it appears as an extra constraint. Without any negative incidence on the sustainable resource management, it could be withdrawn for the benefit of the sole quota enforcement, that is to say the strict economical rationality, which by itself is able to regulate the number of new constructions and to influence their main characteristics.”

The study then concludes on the Gross Tonnage regulations: “The strict control of new construction tonnage, together with its side rules and inconsistencies should be removed. As a matter of fact, it appears nowadays that, with the predominant role of quotas, this limitation is not necessary anymore, having also in mind that the relation between tonnage and fishing capacity or resource preservation is highly questionable. Remove this limit consists in ‘let alone’ the financial and economic constraint, which, with reasonably well enforced quotas, is sufficient for preventing uncontrolled increase in the number and sizes of vessel. At the European level, the translation of this proposal is, at least, the deletion of the regulations that limit new constructions gross tonnage, and, ideally, the associated deletion of the framing of fishing fleets with an overall authorised GT amount”

6.4 Concerns in IMO on Gross Tonnage

Also in IMO gremials the detrimental influence of GT on safety and comfort is discussed.

¹³ Renault, Pinon, Douliazel, Ergospace, research on the interaction between working spaces, ergonomics and prevention of occupational accidents on board fishing vessels, IMP, November 2007.

The following documents are mentioned:

Submittance to the 81st session of the Maritime Safety Committee¹⁴, with the following statement: “The Netherlands has contributed to this discussion by submitting document SLF 46/15/2 in which attention was not only drawn to the economic disadvantages linked to the present methodology for the measurement of tonnage for open-top containerships, but also to the safety effects and the adverse effects on the on-board living conditions for the crew”.

At the SLF 48 the results of a study were presented on the consequences of the GT criterion.¹⁵

Submittance of Germany and other countries¹⁶ on deletion of accommodation from Gross Tonnage to stimulate better circumstances for crew.

A resolution of the Maritime Safety Committee of IMO¹⁷, to allow a reduction of the Gross Tonnage of open top container vessels. These vessels have a higher Gross Tonnage, but provide also a higher safety for dockworkers and lower loss of containers at sea, than comparable containerships without open top.

Significant in this context is the possibility to reduce the Gross Tonnage of oil tankers when they are fitted with segregated ballast tanks, which result in much more GT's than older tankers with combined tanks. Increased safety for the environment was obviously hindered by the application of Gross Tonnage rules, but was encouraged by this measure of reduced Gross Tonnage.¹⁸ This measure of allowing reduction of actual GT to encourage higher safety was fully supported by the EC.¹⁹

6.5 Concerns in ILO on Gross Tonnage

Resolution concerning tonnage measurement and accommodation, adopted by the ILC at its 96th Session, 2007.²⁰

Submittance of ILO²¹ on concern on crew comfort as consequence of Gross Tonnage restrictions.

“Noting the difficulties caused by making an equivalence between the measurement of the size of vessels in terms of length and gross tonnage and the impact it has in the fishing industries. Recognizing the impact the International Convention on Tonnage Measurement of Ships, 1969, has on the safe design of vessels, including their accommodation. Recognizing also the importance of accommodation for the provision of decent work for fishers.”

“However, he noted that there remained concern that the 1969 TM Convention had led to an economic disincentive for ship owners to improve such crew conditions, in particular by discouraging, by increasing associated costs, the provision of more than the minimum required accommodation space and the provision of accommodation space for carrying cadets.”

“The ILO notes that the submission from Germany reflects the principle that ship owners and fishing vessel owners should not be faced with an economic disincentive when they

¹⁴ MSC 81/23/25, 21 March 2006 Review of 1969 Tonnage Measurement Convention

¹⁵ Policy Research Corporation, 2005, Consequences of the Gross Tonnage Measurement, a discussion document.

¹⁶ Sub-committee on stability and load lines and on fishing vessel safety SLF 55/9/3, 2012. Reduced Gross Tonnage for accommodation spaces. Submitted by Germany, India, the United States and the International Transport Workers' Federation (ITF)

¹⁷ MSC 234(82). Recommendations concerning tonnage measurement of open-top containerships

¹⁸ Resolution A.747(18) on oil tanker segregated ballast spaces.

¹⁹ Official Journal EC, 22 October 1994. Opinion on the proposal for a Council Regulation on the implementation of IMO Resolution A.747(18), on the application of tonnage measurement of ballast spaces in segregated ballast oil tankers.

²⁰ Resolution concerning tonnage measurement and accommodation, 96th Session ILC, adopted on 12 June 2007.

²¹ MSC 89/9/8, 22 March 2011, Guidelines to improve the effect of the 1969 TM Convention on ship design and safety. Reduced Gross Tonnage. Submitted by the International Labour Office

wish to build and operate ships and fishing vessels that provide larger accommodation spaces for seafarers or fishermen or provide additional space for the carriage of cadets. Improvements in crew accommodation are important to attracting and retaining seafarers and fishers, especially bearing in mind decreased opportunities for shore leave and the fast turnaround times of vessels in port. Providing sufficient space for the carriage of cadets is important to ensuring the future of the shipping and fishing sectors. Efforts to improve accommodation and to ensure sufficient accommodation space for cadets respects IMO's aim to address the human element in all of its work and contributes to improving safety at sea and the protecting the marine environment.”

6.6 Concerns in AMRIE on Gross Tonnage

On request of the European framework programme MEPC a study was made by AMRIE, the former Alliance of Maritime Regional Interests in Europe, and the Institute für Seeverkehrswirtschaft and Logistik, ISL, on the negative consequences of gross tonnage measurement²². It is a.o. concluded that GT has seriously influenced design of container vessels for short sea operations with potentially disastrous safety consequences.

6.7 Concerns in EU on Gross Tonnage

The EU is currently working on a “Regulation on the Conservation of fishery resources and the protection of marine ecosystems through technical measures”²³. An amendment is now formulated to exclude from the Gross Tonnage calculation extra space for safety and comfort and the storage of discards on *new* and existing vessels:

“Amendment. Section 5a. Adaptation of Fishing Vessels. Article 17c. Adaptation of tonnage.

On new and existing fishing vessels, increases in the tonnage of the vessel intended to improve safety on board, working conditions and the hygiene and quality of products, as well as increases in the tonnage of the vessel intended to store unwanted catches subject to the landing obligation in accordance with Article 15 of Reg (EU) No 1380/2013 shall be authorised, provided that they do not result in an increase in the vessel's catch potential. The corresponding volumes shall not be taken into account for the purpose of assessing fishing capacity in the light of the ceilings imposed in Annex II to Regulation (EU) No 1380/2013 or in the entry/exit schemes referred to in Article 23 of that Regulation.”

This amendment is justified by French Member of the European Parliament, Mr Cadec, as follows:

“An increase in the tonnage of vessels should be authorised where the additional volumes correspond to the need to store unwanted catches which must in future be landed and the need for safety and comfort for crews.”

²² ISL AMRIE Tonnage Measurement Study. MTCP work package 2.1, Bremen/Brussels, November 2006. Summarized in

²³ Draft European parliament legislative resolution. Conservation of fishery resources and the protection of marine ecosystems through technical measures, amending 1967/2006, 1098/2007, 1224/2009, 1343/2011 and 1380/2013.

7 Safety framework for fishing

7.1 International agreements on safety in fishing

According ²⁴, Annex 2, the following international agreements, both binding and voluntary are available for fishing vessels, status 2008:

1. Standard specifications for the marking and identification of fishing vessels (FAO, 1989) (voluntary)
2. Code of Conduct for Responsible Fisheries (FAO, 1995) (voluntary)
3. Convention on the International Regulations for Preventing Collisions at Sea (COLREGs), 1972
4. International Convention for the Safety of Life at Sea (SOLAS), 1974, its Amendments and Protocols(note: not in force erroneously mentioned)
5. International Convention on Maritime Search and Rescue, 1979
6. Torremolinos International Convention on the Safety of Fishing Vessels, 1977 and the Torremolinos Protocol of 1993 relating thereto (not in force)
7. Code of Safety for Fishermen and Fishing Vessels, Part A (as revised) (voluntary)
8. Code of Safety for Fishermen and Fishing Vessels, Part B (as revised) (voluntary)
9. Voluntary Guidelines for the Design, Construction and Equipment of Small Fishing Vessels (as revised) (voluntary)
10. Safety recommendations for decked fishing vessels of less than 12 m in length and undecked fishing vessels (voluntary)
11. Guidelines to assist competent authorities in the implementation of Part B of the Code of Safety for Fishermen and Fishing Vessels, the Voluntary Guidelines and the Safety recommendations (voluntary)
12. International Convention on Standards of Training, Certification and Watch keeping for Fishing Vessel Personnel (STCW-F), 1995 (not in force)
13. Document for Guidance on Training and Certification of Fishing Vessel Personnel (voluntary)
14. International Convention for the Prevention of Pollution from Ships (MARPOL 73/78)
15. ILO Work in Fishing Convention (not in force). note writer: in the mean time in force

7.2 EU measures for safety and health for fishing vessels

7.2.1 General

Fishing vessel safety is regulated according Council Directive 97/70/EC of 11 December 1997²⁵, setting up a harmonised safety regime for fishing vessels of 24 metres in length and over. This Directive is largely based on the Torremolinos International Convention for the Safety of Fishing Vessels 1977, abbreviated as the 'Torremolinos Protocol'.

Intention of the Directive is also to harmonize the different and varying national safety requirements, ensure that competition will take place on an equal level for fishing vessels operating in the same area without compromising safety standards.

Important extension is the application of the Torremolinos protocol also to vessels of less than 45 m in length but more than 24 m.

²⁴ FAO Report no 888; Report of the Expert consultation on best practices for safety at sea in the fisheries sector, Rome November 2008

²⁵ Council Directive 97/70/EC of 11 December 1997 setting up a harmonized safety regime for fishing vessels of 24 meters in length and over

It is further stated that equipment installed on fishing vessels should be automatically recognized when complying with Council Directive 96/98/EC of 20 December 1996 on marine equipment.

It is recognized that at present there are no uniform international technical standards for fishing vessels as regards their hull strength, main and auxiliary machinery and electrical and automatic plants, such standards may be fixed according to the rules of recognized organisations or national administrations.

The Directive 97/70/EC is related to the provisions of Council Directive 89/391/EEC of 12 June 1989 on the introduction of measures to encourage improvements in the safety and health of workers at work, and CD 93/103/EC of 23 November 1993 concerning the minimum health and safety requirements for work on board fishing vessels (13 th individual Directive within the meaning of article 16(1) of Directive 89/391/EEC.²⁶

²⁶ CD 93/103/EC of 23 November 1993 concerning the minimum safety and health requirements for work on board fishing vessels (thirteenth individual Directive within the meaning of Article 16 (1) of Directive 89/391/EEC)

8 Impact of GT restrictions on safety, comfort and economy

8.1 General

Smaller ships are more vulnerable for the forces of the sea than larger ships. The waves have the same height for small and large ships, but are relatively larger for the smaller ships. It is also recognized that according estimates by the ILO, fisherman is a dangerous profession with 160 deaths and 2527 injuries in 1998.²⁷ In a plea to adopt the Torremolinos Protocol a.o. the following is mentioned:

“H. whereas work in this sector is not carried out in proper conditions owing, in part, to economic and competition pressures which compel fishermen and ship owners to take more risks, such as cutting crews and increasing working hours, leading to accidents due to extreme fatigue,

I. whereas weather conditions have an enormous influence on fishing activities, not only determining whether or not it is possible to go on fishing trips but also having an impact on accidents on board and the number of accidents,

J. whereas working conditions for fishermen have a direct impact on the number and severity of accidents in the sector and, in this sense, Council Directive 93/104/EC on certain aspects of the organization of working time, amended by Directive 2000/34/EC of the European Parliament and the Council, does not guarantee the necessary rest nor adequate organization of work”

Despite the adoption of the Torremolinos Protocol especially the weather and the competing circumstances remain in the sector and as less as possible restrictions should be introduced which could be contra-productive in achieving extra safety.

8.2 Pressure on safety through GT limitations

This means that restrictions on Gross Tonnage and kW are contra-productive in achieving more safety. As limits on Gross Tonnage stimulates that ships will be designed at the limits of the safety requirements. Extra safety in the form of e.g. more freeboard above the minimum or bow heights above the minimum will be punished.

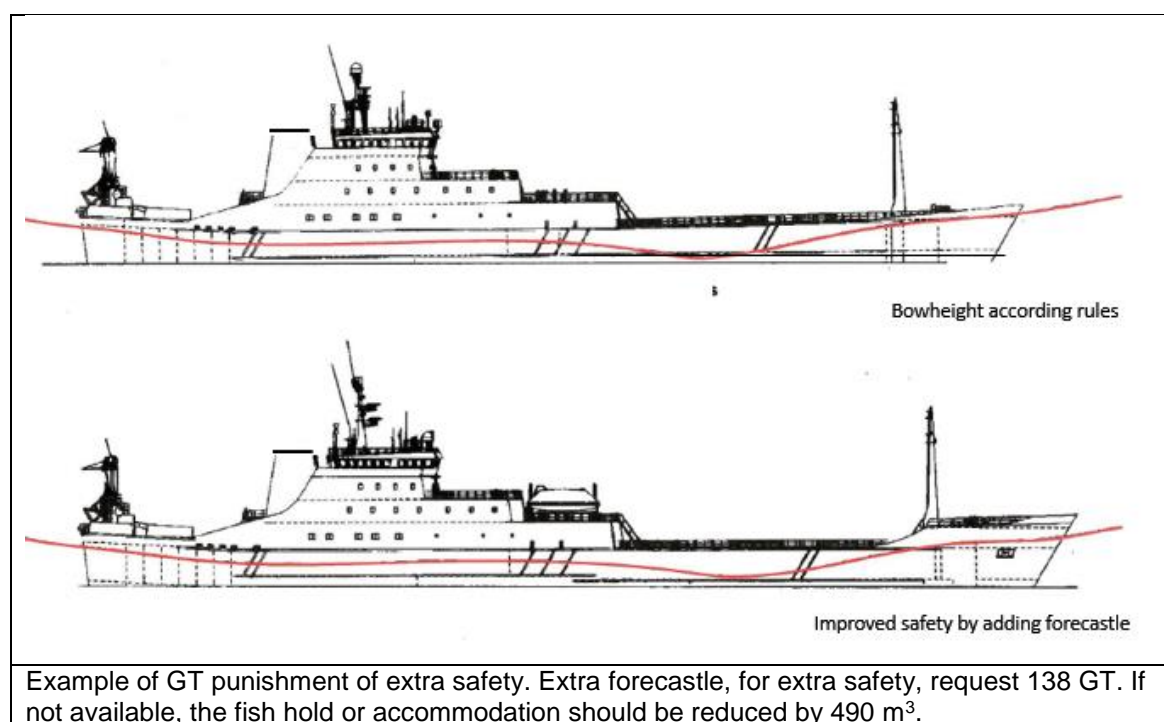

²⁷ Resolution European Parliament of 2 to 5 April 2001 concerning safety and causes of accidents. Discussed by the Maritime Safety Committee at its 75th session, 10 October 2001

8.3 Pressure on crew comfort through GT limitations

Another example is the punishment for extra crew accommodation or comfort: GT punishment is contra-productive for enhancing crew accommodation area above the bare minimum as requested by ILO.

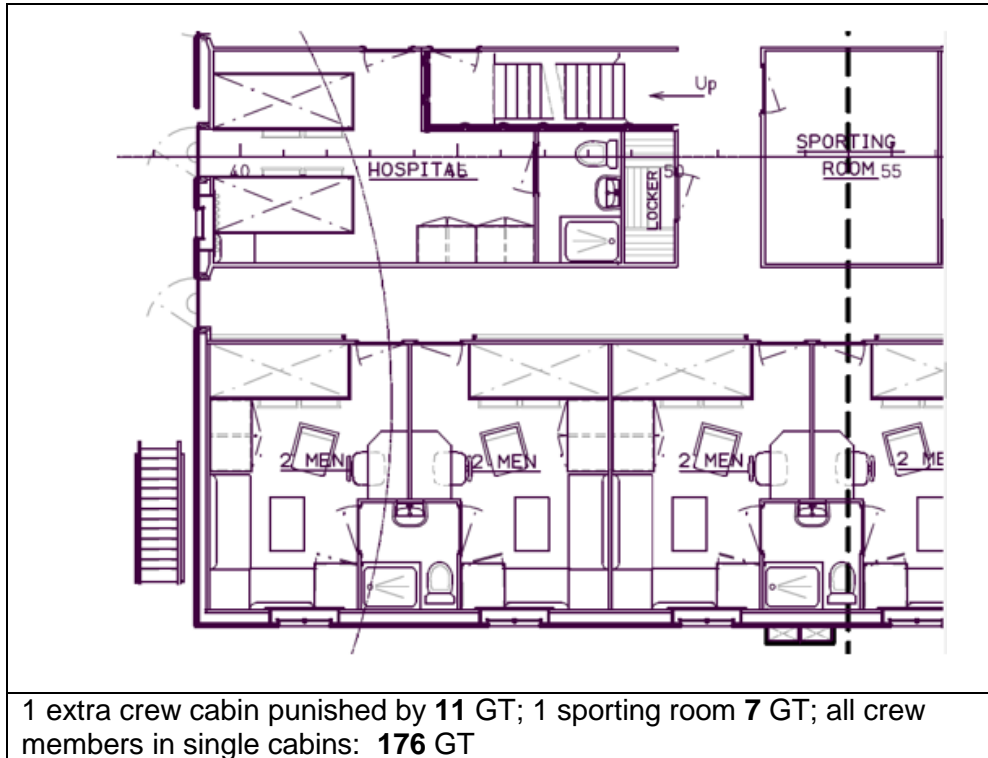

8.4 Pressure on economy through GT limitations

The GT limitation will not limit the catch, because this is already limited by the allowed TAC's, independent of GT.

But the GT limitation will deteriorate the economic operation. This can be explained by an example. If a given TAC, say of 10 000 ton, has to be caught at a certain distance, say 500 nautical miles from the homeport, then, apart from the fishing and freezing time, the vessel has to sail every year:

Number of single trips: $2x$ (10 000/hold capacity) x 500 nautical miles:

Hold limited to: (tons)	Number of trips per year	Sailing distance per year (miles)	Sailing time at 12 knots (days)	Fuel consumption/year sailing with 2000 kW	CO2 production while sailing
500	20	20000	69	690 t	2070 t
1000	10	10000	35	350 t	1050 t
2000	5	5000	17	170 t	510 t

It is in case of fishing at a certain distance from the homeport therefore economical and sustainable to have a hold capacity which is in balance with the sailing distance. This should not be limited by GT limitations, as the catch per year is already limited by TAC's.

8.5 Pressure on safety through kW limitations

The following interesting example shows the detrimental influence of a kW limitation of a fishing boat which has no relation to the catching capacity of the boat.

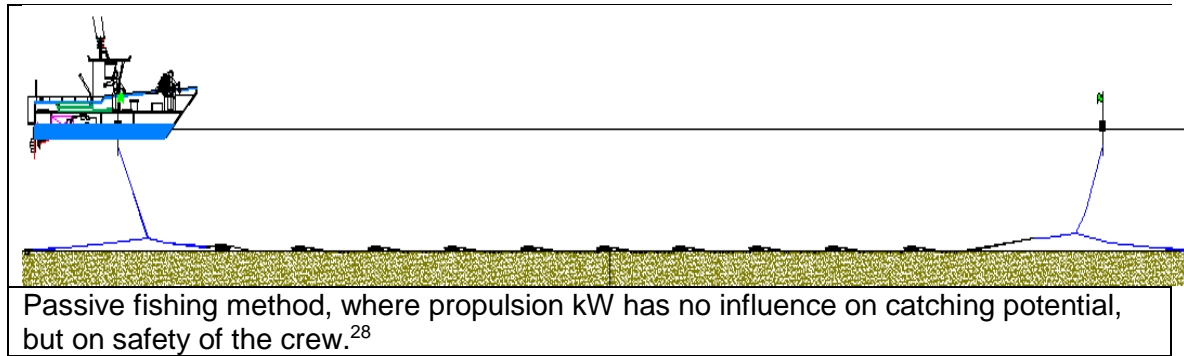

In this case of a passive fishing method with caves there is no relation between engine power and fishing potential. But the limitation of the kW of the engine will reduce the speed of the boat when sailing home in case of upcoming bad weather and thus is deteriorating the safety of the crew in this operation.

²⁸ Bellavista, M., Stefanini, A., Technical report on the fishing capacity correlated to GT and kW in the field of small fishing boats with fixed gear, Februar 2018

9 Kilowatts not an adequate parameter for fishing capacity

9.1 General

In this chapter we will investigate whether engine power is an adequate parameter to characterize the fishing capacity of a fishing vessel. Earlier studies have questioned the relevance of kilowatts or engine power for the fishing capacity²⁹, from which we cite the summary:

“Fishing vessel capacity for trawlers is generally expressed in terms of length, tonnage, and engine power, assuming that a larger vessel has a greater fishing power. Management uses effort-control measures such as kW-day limits based on this assumption. Many studies have shown a weak and noisy relationship between effort and modelled catches, and explanatory models often require the inclusion of a skipper or vessel effect to explain the variance. A key element in this effect is the choice of gear size. Relationships are investigated between metrics of the vessel (length, tonnage and power) and the gear towed (length of ground gear, or circumference of the net opening) in trawlers. Often, the vessel size did not correlate with that of the gear, or did so only for smaller vessels. The key implication is that effort management based on vessel metrics alone is not appropriate, because it is a poor predictor for gear size, and hence for fishing power. Effort restrictions may actually encourage the adaptation of larger gears for a given vessel, to maximize the value of a limited-time resource”.

9.2 Definition of engine power

According Regulation EU 2017/1130 of June 14, 2017, the characterisation of a fishing vessel is apart from its Gross Tonnage, defined by its engine power:

“The engine power shall be the total of the maximum continuous power which can be obtained at the flywheel of each engine and which can, by mechanical, electrical, hydraulic or other means, be applied to vessel propulsion. However, where a gearbox is incorporated into the engine, the power shall be measured at the gearbox output flange. No deduction shall be made in respect of auxiliary machines driven by the engine.”

This means that if part of the engine power can not be applied for propulsion (e.g. when the output to the propulsor is limited) it should not be taken into account.

The currently most common configuration for power generation and propulsion on board fishing vessels is as follows:

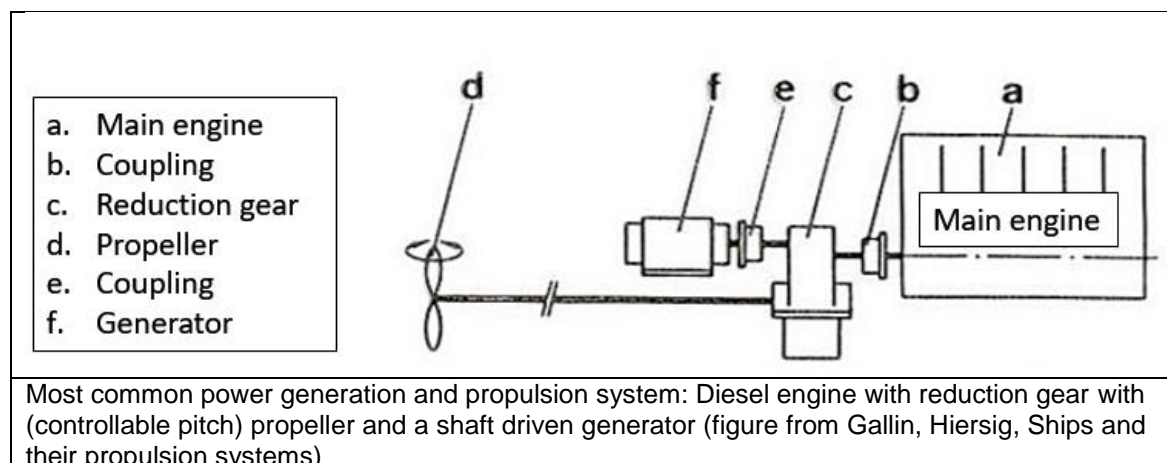

²⁹ Reid, D.G. et al : Do big boats tow big nets? ICES journal of Marine Science, Volume 68, September 2011

In the near future probably the following configuration will become familiar:

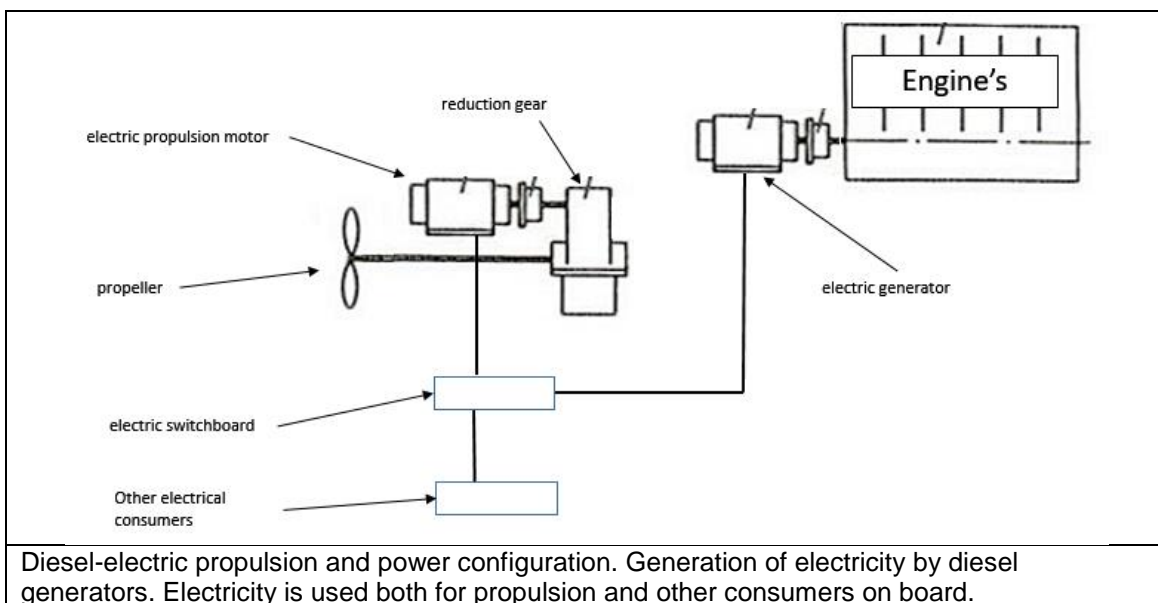

9.3 Types of propulsor

The application of a nozzle around the propeller can improve the thrust per kilowatt with 20-25%. Therefore almost all pelagic trawlers are fitted with nozzles around their propellers. Also most diesel-direct driven trawlers are fitted with controllable pitch propellers and shaft alternators. The latest development is the application of diesel-electric propulsion and twin propeller propulsion, giving a further 20% improvement of the pulling force per kilowatt power.

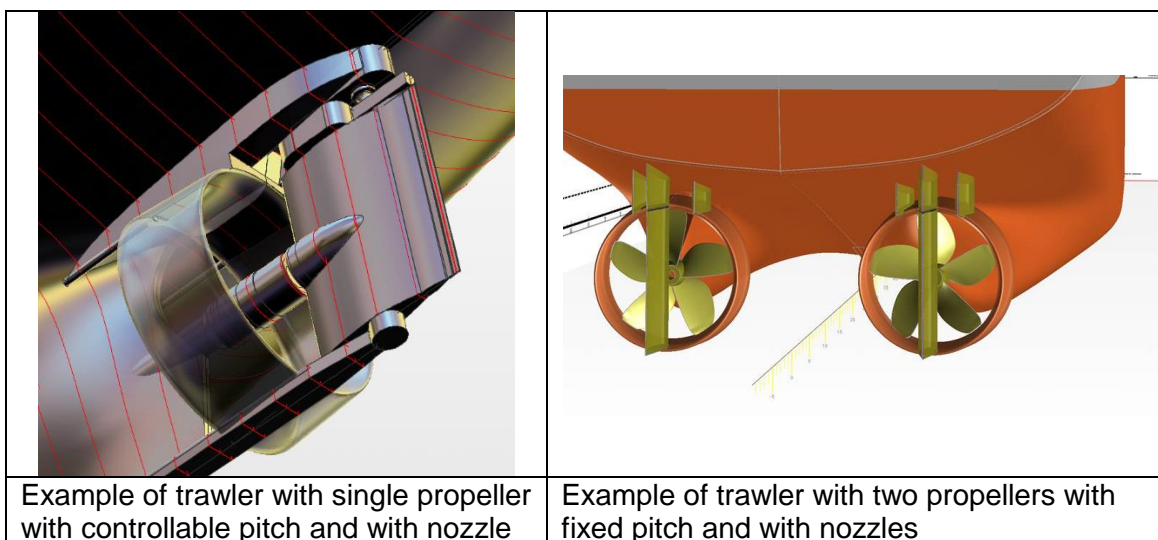

9.4 Pulling force of trawlers

It can be shown that the pulling force T in tons, which a propeller can develop, depends on the power P in kW, on the propeller diameter D_p in m, on the speed V in knots and the type and quality of propeller and hull. This quality- or merit factor is known as the Bendemann factor. For tugs examples were shown for zero speed in ³⁰, for some trawlers, all fitted with a propeller nozzle, this Bendemann factor, including speed and own resistance effect, is shown in the next figure.

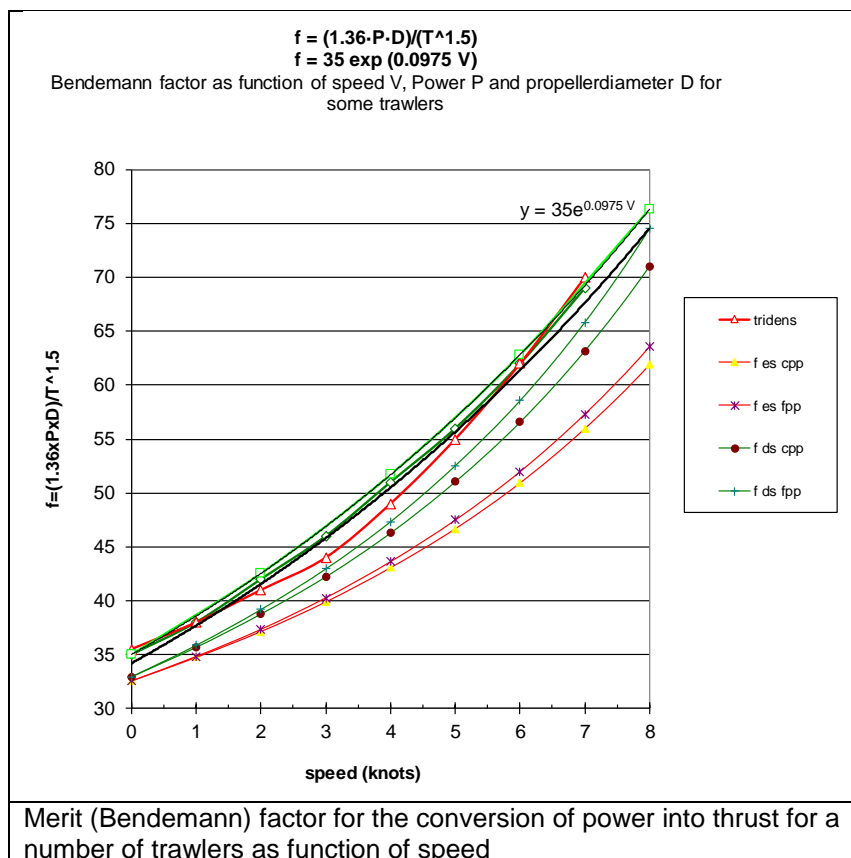

The 'Bendemann' factor is given by:

$$f = (1.36 \times P \times D) / T^{3/2}$$

Which can be rewritten into the following expression for thrust:

$$T = \{(1.36 \times P \times D) / f\}^{2/3}$$

Based on a data of trawlers, as represented in below graph, the following expression for the merit factor f is found as function of speed:

$$f = 35 \exp(0.0975 \times V)$$

Where:

- T = thrust in tons
- P = propulsion power in kW
- D = propeller diameter in m
- V = speed in knots

Combining the last two formula's results in the following expression for the thrust of a propeller as function of its diameter, power and towing speed:

³⁰ Kooren, Quadvlieg, Aalbers, Rotor Tugology, The 16th International Tug & Salvage Convention, June 2000

$$T = \{(1.36 \times P \times D) / (35 \exp(0.0975 \times V))\}^{2/3}$$

Or:

$$T = 0.115 (P \times D)^{2/3} / (\exp(0.0975 \times V))^{2/3}$$

For bollard pull, $V=0$ knots, this formula simplifies to:

$$T = 0.115 (P \times D)^{2/3}$$

For a normal fishing speed of $V=5$ knots:

$$T = 0.115 (P \times D)^{2/3} \times 0.723 = \mathbf{0.083} \times (P \times D)^{2/3}$$

Using this expression it can be shown that dividing the available power over two propellers can increase the total thrust, using the same amount of kW's, by more than 25%:

Total thrust T for two propellers with half of total power P on each propeller for e.g. 5 knots:

$$T_{\text{tot}} = 2 \times 0.083 \times (1/2 P \times D)^{2/3} = 2 \times 0.083 \times (1/2)^{2/3} (P \times D)^{2/3} = \mathbf{0.105} \times (P \times D)^{2/3}$$

This means that a twin screw vessel can achieve: $(0.105/0.083) = 1.26$ more thrust in comparison with a single screw vessel with the same kilowatts and propeller diameter.

In the following picture it is also graphically shown that power kW is equal important to the propeller diameter (and number of propellers) for the determination of the pulling force and with that the size of net which can be pulled.

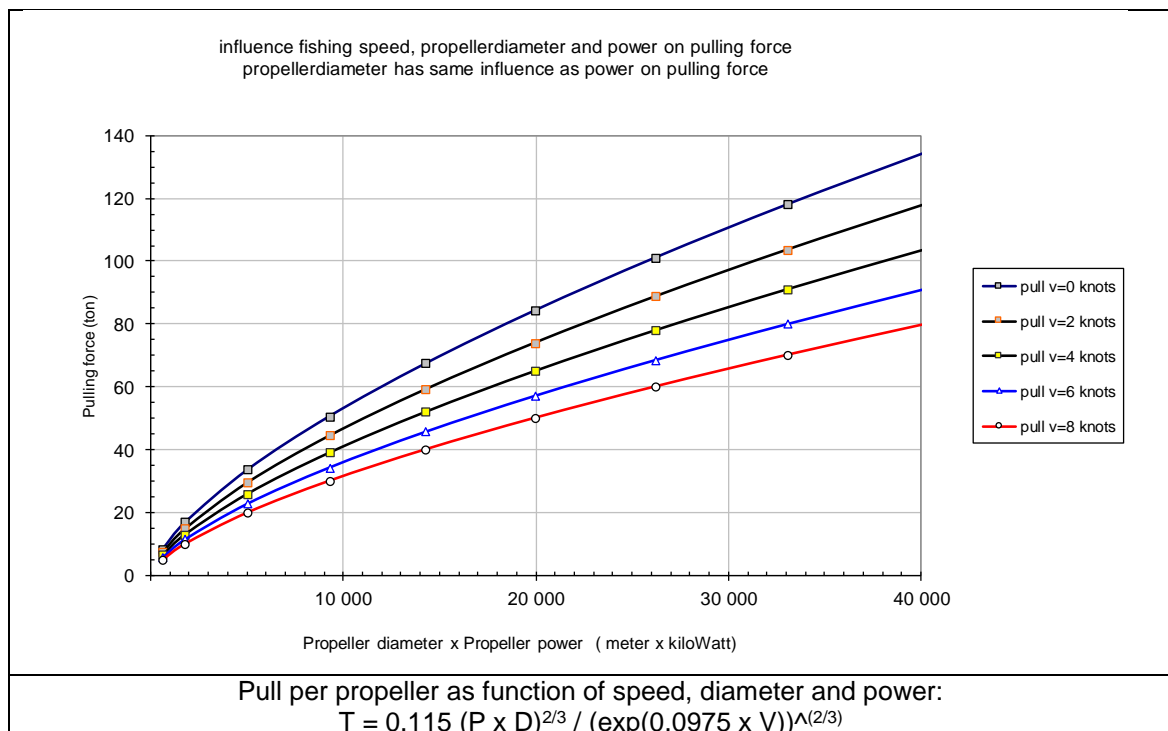

9.5 Conclusion on adequacy of kW as a prediction of pulling power

It is concluded that the kilowatt is a very inaccurate figure to describe the pull of a trawler.

This is elucidated with an example:

A trawler with a given propeller diameter and power can be re-designed in the following steps:

1. Increase the propeller diameter with 20 %. This will increase the pulling force with a factor : $1.2^{2/3} = 1.13$
2. Divide the kilowatts over two propellers with the same diameter, this will improve the pulling force with another factor 1.26
3. The total difference between starting point and final result is then: $1.13 \times 1.26 =$ a factor of 1.42 more pull for the same kilowatts

The fishermen has the responsibility to strive for the highest sustainability and economics to pull the best suited net at the lowest possible propulsion power.

But is not a plea for a pull restriction! But just to show that a at first sight reasonable restriction is not adequate and more is not needed because the fishermen have to keep their catch limited to his maximum TAC.

9.6 The pelagic net

9.6.1 General

The pelagic fishing method is depicted below³¹. Pelagic fishing is performed amply above the bottom of the sea. The net is pulled by the trawler with two warps. Each of the warps is connected to a pelagic trawl door. The trawl doors, one on each side of the net, are used to maintain the opening of the net in the best shape for catching. Between the trawl doors and the net clump weights are connected. to keep the net open in vertical direction.

The size of the net can be expressed in square meters of the net opening or as the circumference in meters or in the number of meshes.

The catching potential of a net seems proportional to the size of the net. This is, however, only the case when the size of the school is larger than the size of the net. Also when the fish is concentrated in a thin layer of the water column, the size of the opening of the net is not decisive, but, given a certain minimum height, the width of the net determines the catching efficiency. Another relation of the relevance of the opening of the net, is when the fish is abundant present. The fisherman then even applies a smaller net than his ship can handle to avoid too large catches in one haul, which would damage the fish.

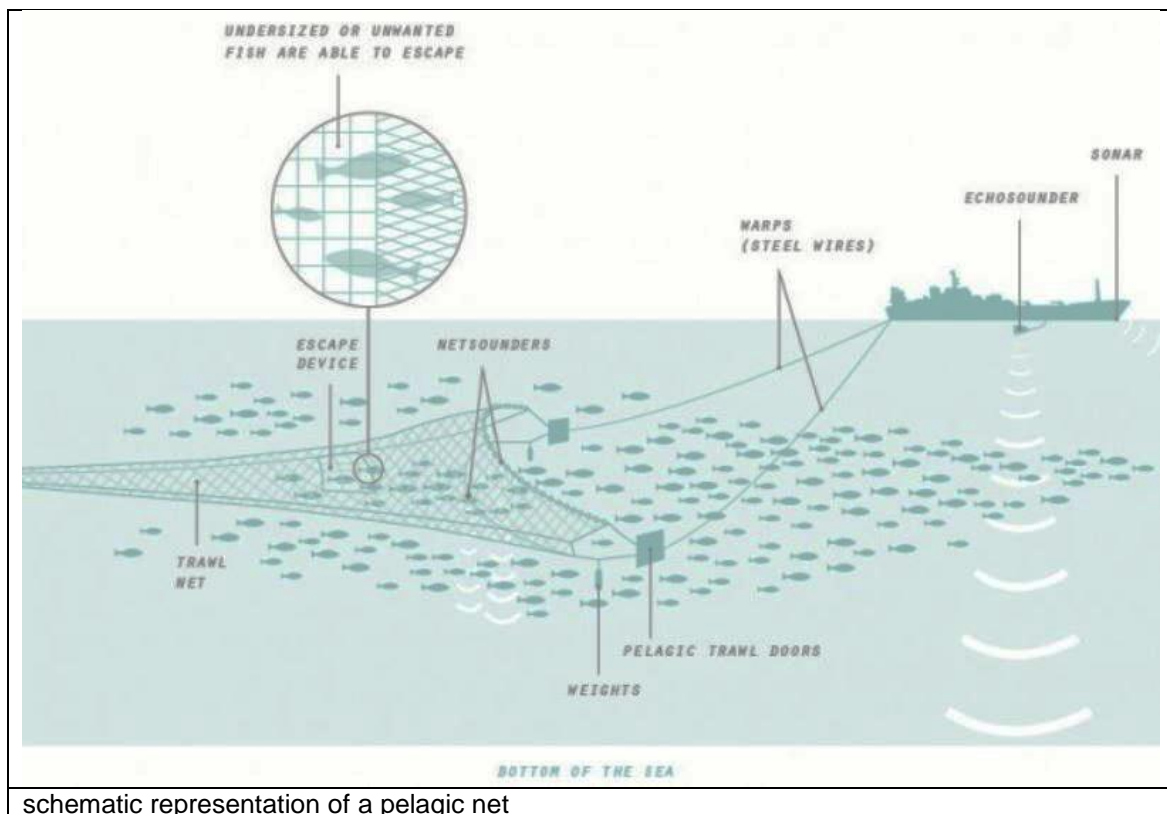

schematic representation of a pelagic net

9.6.2 Net resistance

The catching capacity of a pelagic net is a function of the opening of the net in height and width, which can be expressed in the number of meshes in the circumference of the net.

The propulsion force (which is not equivalent to propulsion power as will be explained later) needed to pull the net with a certain speed through the water depends on:

- The resistance of the netting
- The resistance of the warps, trawl doors and clump weight

³¹ www.pelagicfish.eu/fishingmethods

- The resistance of the ship itself, which depends on its size and on the weather circumstances
- The resistance of the warps, trawl doors and clump weight

The resistance of a net can be estimated by means of a simple formula by Reid.³² The formula contains the speed of the net and the twine area of the net.

$$\text{Net resistance} = \frac{S^2 \times TA}{(54.72 \times S + 115.2)}$$

Where:

Net resistance in tons

S = speed in knots

TA = twine area in m²

The formula contains the speed of the net, which is the speed of the ship, and the twine area of the net.

For some nets the relation between net circumference in meshes and twine area is plotted in the next figure:

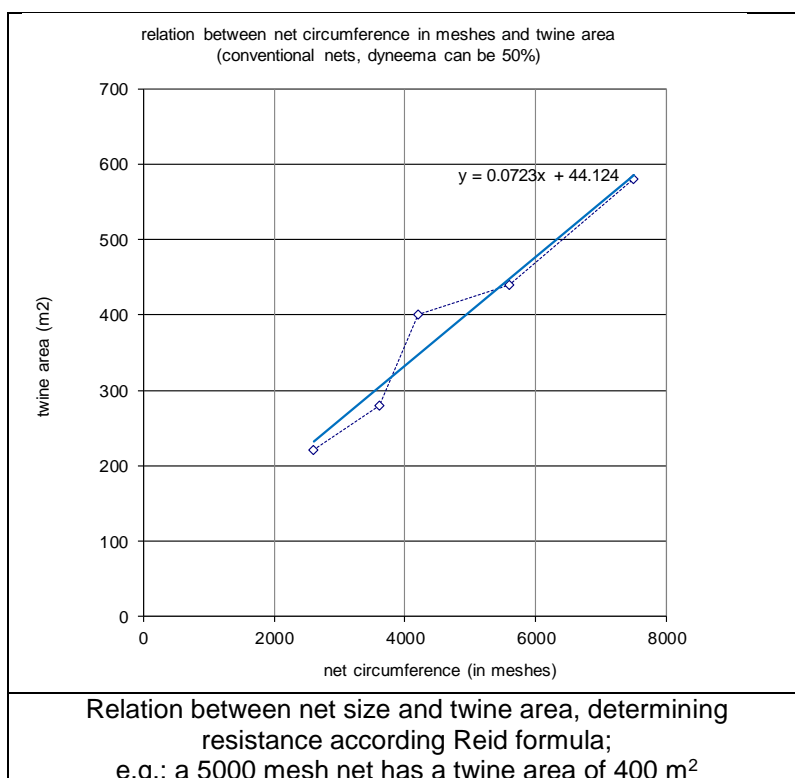

The following estimation can then be applied:

$$TA = 0.0723 \times \text{Mesh} + 44$$

Where:

TA = twine area in m²

Mesh = net circumference in meshes

³² Reid, A.J., A Net Drag Formula for Pelagic Nets, Scottish Fisheries Research Report Nr 7, 1977.

Based on model tests with nets complete with trawl doors and wires, the resistance of the complete net can be estimated between 1.0 and 1.9 times the with the formula of Reid calculated net resistance. A reasonable value for normal nets 1.75, or :

$$\text{Total resistance} = 1.75 \times \text{Reid net resistance}$$



Examples of various nets of normal twine material are shown in the next figure. For instance the total resistance of a # 6300, circumference 1260 m, amounts to 56 tons.

- 6300 meshes net has twine area of: $0.0723 \times 6300 + 44 = 499 \text{ m}^2$
- twine area of 499 m^2 and speed 5 knots gives net resistance of: $(5^2 \times 499) / (54.72 \times 5 + 115.2) = 32 \text{ ton}$.
- model test shows 56 ton, apparent factor for doors and wires in this case = $56/32 = 1.75$.

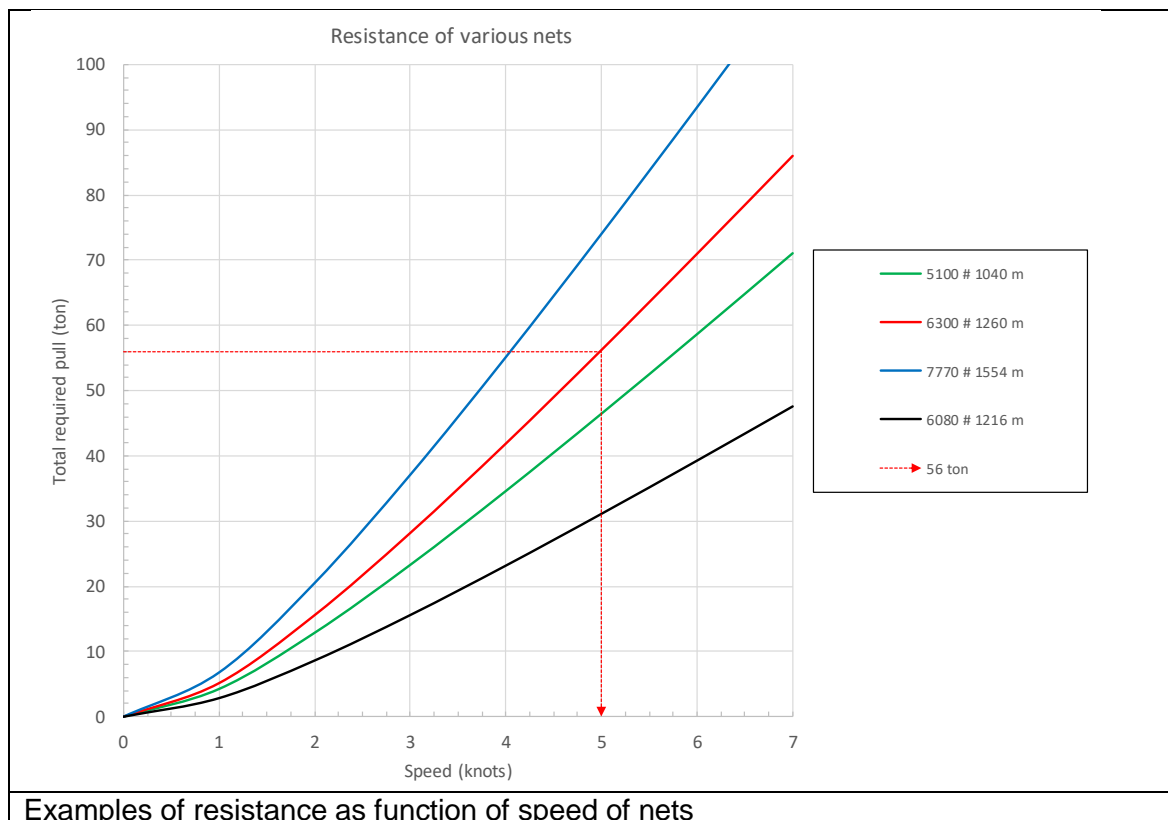
Note that large differences can occur due to design of nets and doors, see the 6080 # net which is much lower than the 5100 # net.



In particular large reductions of net resistance can be achieved with the application of high efficiency trawl doors. But in particular with the application of high tensile twines e.g. dynema. These high tensile twines can reduce the required thickness with 50%, which also reduces the twine area and net resistance with 50%, as also the trawl doors and wires can be reduced.

<p>With 50% less diameter, 1.5mm Dynema netting with a breaking force of 290kg or 639 lbs is 100% stronger than regular the 3mm green PE below.</p>  <p>Regular 3mm PE netting with a breaking force of 140kg or 308 lbs</p> 	
<p>Reduction of more than 50% of twine area possible by application of advanced twines, e.g. from 3 mm to 1.5 mm (dynema)</p>	<p>New types of trawl door can reduce drag of trawl doors with 25% (Voisin)</p>

9.7 Conclusion on kW and nets

It can be questioned if net size is determining catching capacity:

- Studies show that, above a certain size, bigger boats do not necessarily tow proportionally bigger nets³³. In those boats apparent no gain is achieved by applying more kW's for bigger nets.
- In some métiers with vulnerable fish like herring, the skippers choose, despite their ample available kW's, for smaller nets to avoid too *much* catch in a haul
- If the rationale behind the kW limitation would be the limitation of towing force, and with that, of net size, this rationale is not valid any more due to the technological developments which can reduce the drag of nets of a certain circumference with more than 50%.
- This makes a kW limitation useless and not necessary because the fishermen have to limit their catch according his TAC.

³³ Reid, D.G. et al : Do big boats tow big nets? ICES journal of Marine Science, Volume 68, September 2011

10 Theoretical fishing capacity of a trawler

10.1 General

A pelagic freezer trawler catches species like herring, mackerel, horse mackerel and sardinellas with midwater trawls in water depths of 50-400 m. After catching the fish is pre-cooled to 0° C and stored for maximum 24 hours in refrigerated sea water buffer tanks. After sorting on size and specie, but without any treatment, the fish is deep frozen in blocks with a weight of 20-25 kg. After being frozen the blocks are packed in cartons and stored in the deepfreeze holds.

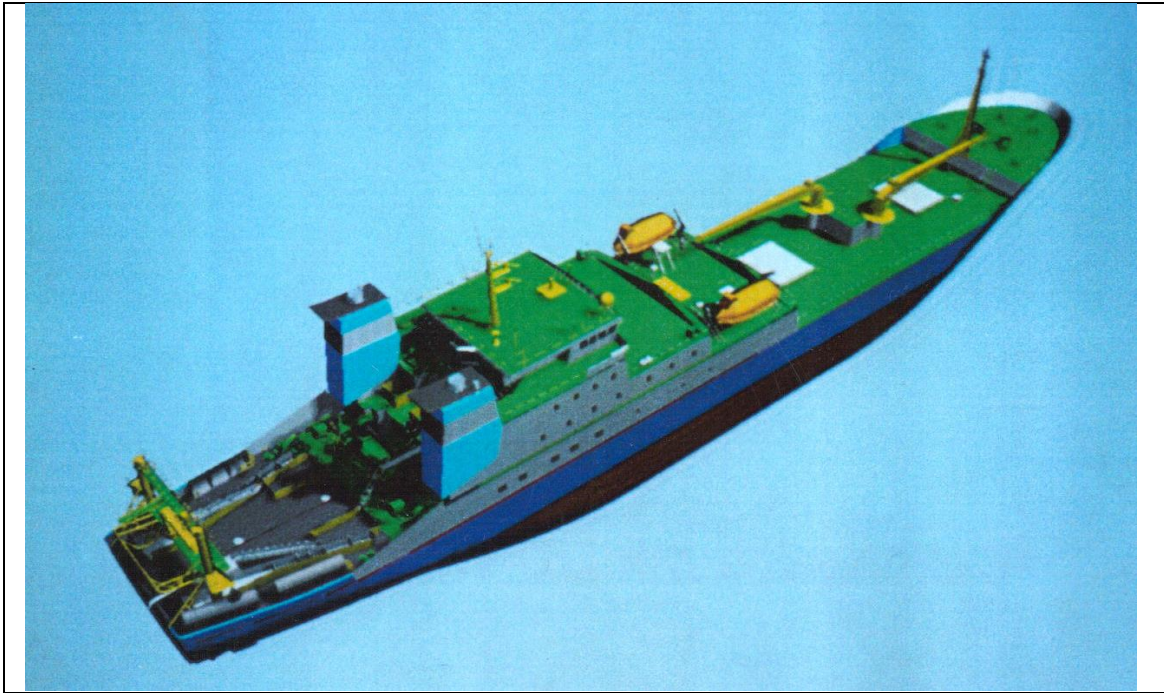

example pelagic trawler

The daily fishing capacity of a deepfreeze trawler is in the first place limited by the capacity of the deepfreeze plant and in the second place by the hold capacity. This in contrary to the daily fishing capacity of e.g. a pure RSW pelagic trawler (tank boat), which is only limited by the tank volume.

There is a strong relation between GT and the product of Length, Beam and Depth:

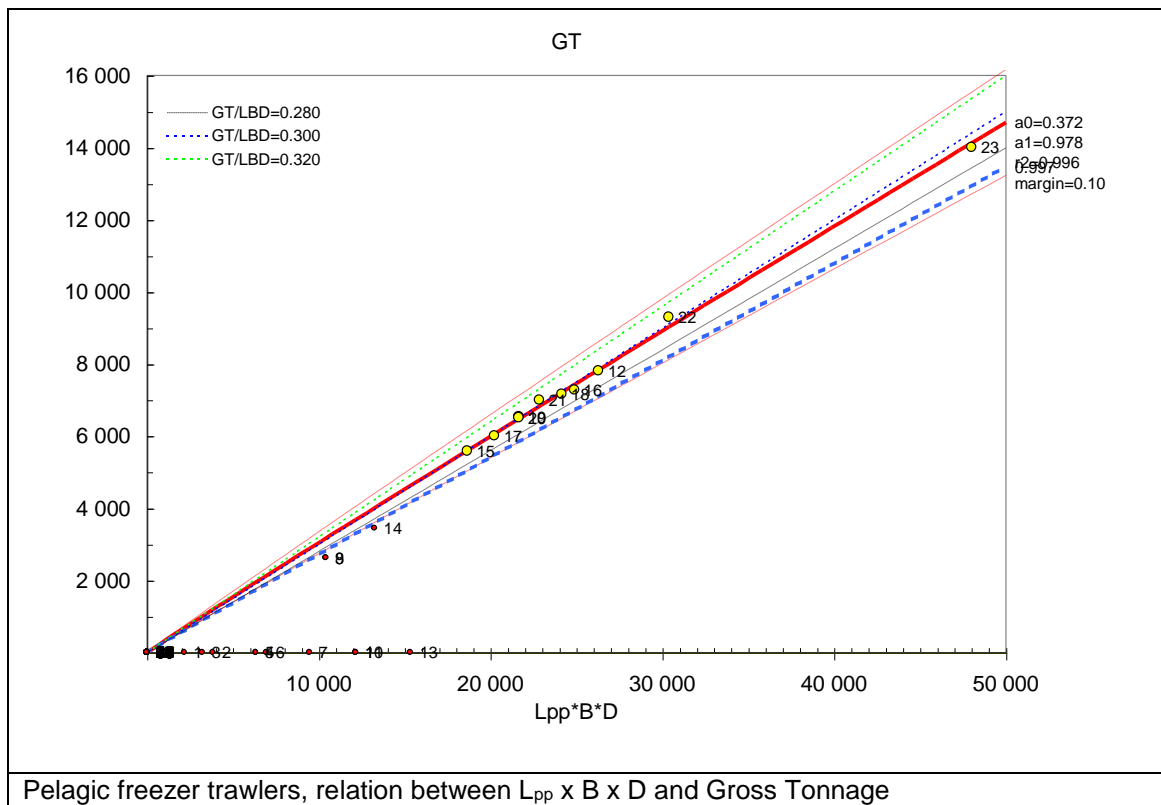

There is also a quite strong relation between the cargo hold volume and $L_{pp} \times B \times D$:

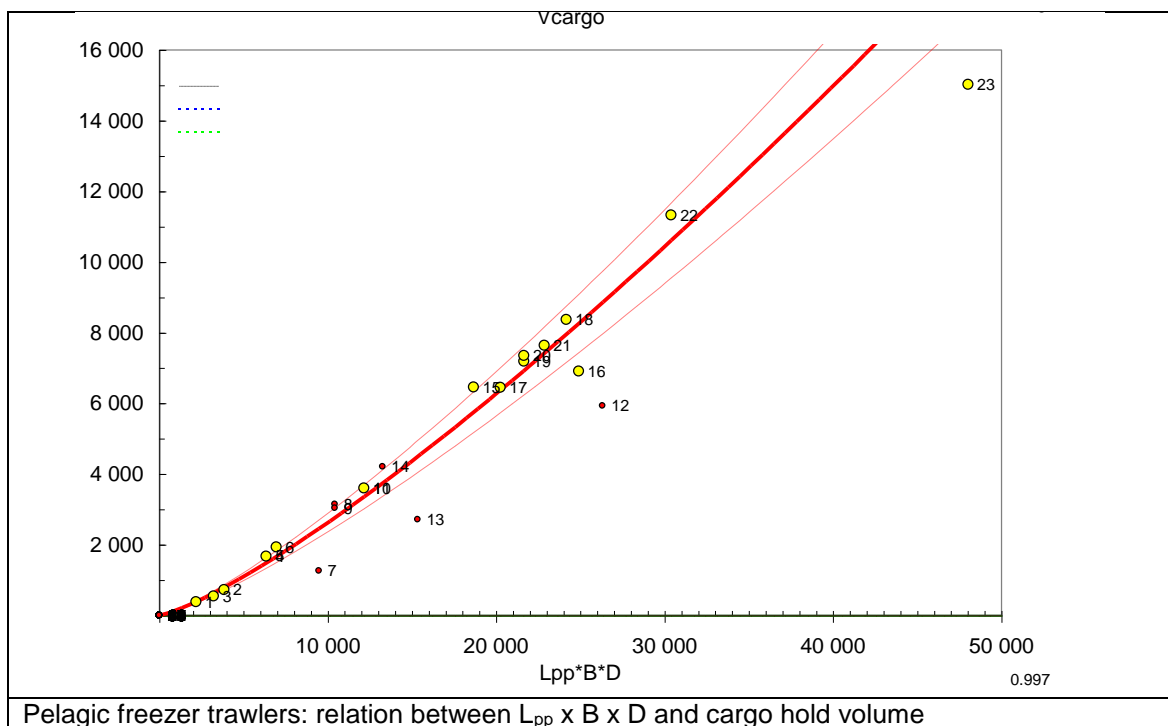

10.2 Previous investigations

In 1989 van Marle published a study on the landing capacity of pelagic trawlers³⁴. A further study was given by de Wilde c.s.³⁵ The influence of steaming time and port delay is for a specific trawler, calculated by van Marle as follows:

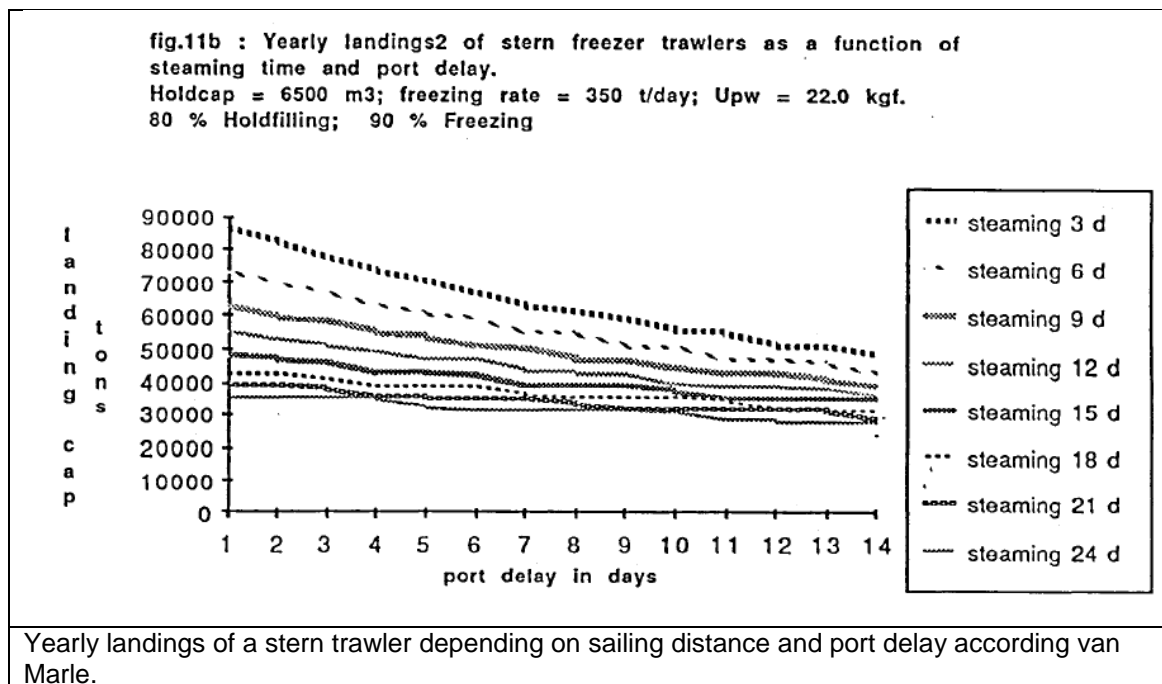

10.3 Operational profile

In the operational profile 13 phases in a roundtrip are described. Certain phases, like steaming to fishing grounds, are only performed once, other like hauling net, up to 80-100 times per trip.

1. Unloading cargo, maintenance, crew change in harbor
2. Sailing to fishing area without refrigerating plant in operation
3. Sailing to fishing area with precooling of tanks
4. Search for fish
5. Setting the net
6. Fishing under normal weather conditions
7. Fishing under heavy weather conditions
8. Hauling the net
9. Pumping fish out of the net
10. Pump handling
11. Freezing the fish with full tanks while floating without propulsion
12. Sailing back to harbor
13. Manoeuvring

10.3.1 Harbour

The time in harbour is determined by the hold capacity and the unloading capacity with shore- or ship born cranes.

In our example we assume a hold capacity of 100 000 blocks, with a block weight of 22.5 kg, in total 2250 ton; with an unloading capacity of the shore cranes of 7 500 blocks per

³⁴ van Marle, B. A preliminary study on the landing capacity of stern freezer trawlers. International council for the exploration of the sea. CM 1989/B50. Fish Capture Committee.

³⁵ de Wilde J.W., Economic results of stern freezer trawlers in relation to technical parameters. LEI Fishery Division, Med No 412, 1989.

hour this will result in a net unloading time of $100\,000/7\,500 = 13.3$ h. As also maintenance has to be performed and crew change or rest is needed, the minimum time in harbour is set at 5 days per trip.

10.3.2 Sailing to fishing area

The distance to the fishing area can be between 200 up to 1200 nautical miles. With an assumed speed of 14 knots this will result in a sailing time between 14 and 85 hours (3.5 days). This sailing distance has a large influence on the total duration of the trip as will be shown.

10.3.3 Sailing and cooling down

Some 12 hours before arrival at the fishing grounds the pre-cooling of the RSW tanks is started. This will not influence the cycle time, but is mentioned for completeness.

10.3.4 Searching for fish

The searching of fish with electronic instruments is performed with a speed of abt 11 knots. It is estimated that a mean period of 4-6 hours per 24 hours is needed to find the fish. On the other hand for certain species and periods, like herring in the good season, no searching time is needed at all.

10.3.5 Setting the net

After arrival at an area with fish the net is set. The time needed for setting the net depends on the available setting speed of the trawl winch, which is taken as 90 m/min and of the required length of the warps. These depend on the fishing depth. As a mean value over the year we assume a warp length of 840 m. This results in a time for setting the net for fishing of $840/90 = 9$ minutes per setting.

10.3.6 Fishing

It is very difficult to predict the required time for fishing. Experience learns that the number of shoots of maximum 3-4 hours to maintain the quality of the fish, can range between 40 for a 'good' trip up to 80 for a 'bad' trip. The catch in ton per shoot is reported to be statistically 'normal' distributed³⁶. Assuming 50 shoots per trip, with a possible maximum catch of 457 ton (small chance of one in every ten trips) could give the following distribution:

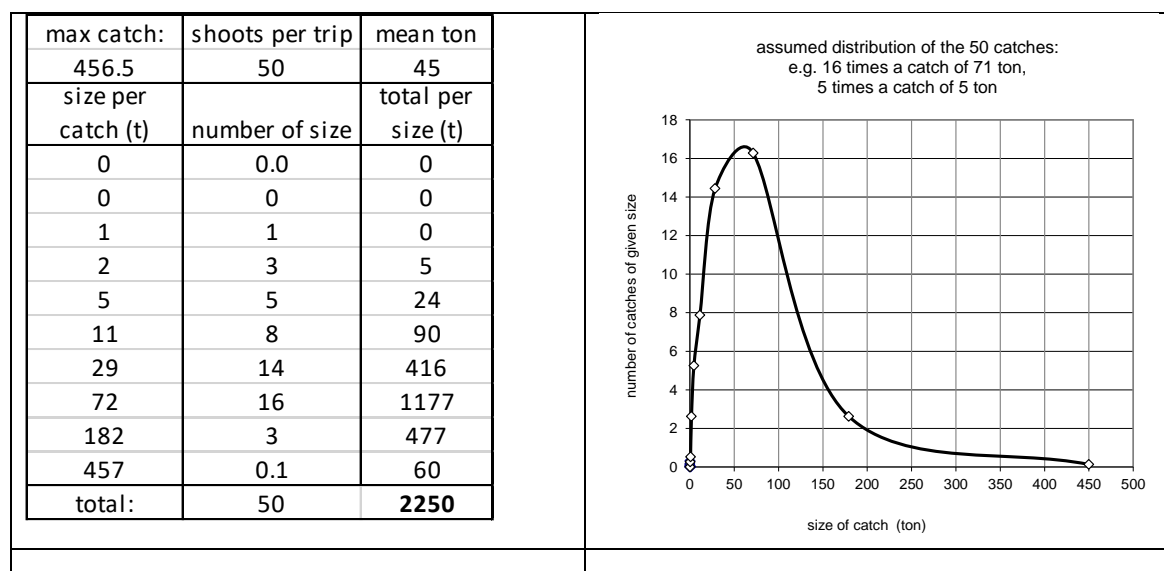

This gives a mean catch of 45 ton per shoot. With a design freezing rate of 225 ton per day this would mean $225/45 = 5$ shoots per day. With a maximum of 3 hours per shoot, this would require an available 'fishing window' e.g. in the night, of $5 \times 3 = 15$ hours.

³⁶ Inoue, Y., Matsuoka, T., Distribution of catch per haul in trawl and purse seine fisheries: implications for reduction of fishing capacity.

But let us assume ideal circumstances, where the skipper is able to catch as much as the deepfreeze installation is able to freeze.

The deepfreeze installation is often dimensioned such that the hold can be filled in 10 days. In this case the deepfreeze capacity would be: $2250 \text{ ton}/10 \text{ days} = 225 \text{ ton/day}$.

The minimum fishing time is then 10 days or 240 hours per trip.

The fishing speed is about 5 knots.

10.3.7 Hauling of the net

After 3-5 hours or earlier when detected with sonar to be filled with fish, the net is hauled in. The required time for that depends on the possible hauling speed and the length of the warps. With a hauling speed of 19 m/min and a warp length of 840 m, the hauling time is 44 minutes. This means a total hauling time during a trip with 50 shoots, of $44 \times 50 = 2200$ minutes or 37 hours per trip.

10.3.8 Pumping

The fish is pumped while the net stays in the water, from the cod end of the net. The capacity is taken as 400 ton fish/water mixture. With a fish/water ratio of 40% this means a nominal fish pumping capacity of 160 ton/h. This results in a required pumping time of $45/160 = 0.28 \text{ h}$ or 17 minutes per shoot. Which corresponds to $17 \times 50 = 844$ minutes per trip.

10.3.9 Pump handling

The hoisting of the cod end and the handling of the pump is estimated at 10 minutes per shoot or 500 minutes per trip.

10.3.10 Freezing while floating

Fishing is often restricted to certain periods of the day, which results in floating while freezing from the RSW buffers in the period where no fishing is possible. This is taken as 2 hours per 24 hours.

10.3.11 Sailing back

The same sailing distance is taken, however with a lower speed than sailing outward of 12 knots.

10.3.12 Manoeuvring

Manoeuvring time is taken as 6 hours per trip.

10.4 Fishing capacity

The fishing time can be composed of :

1. Harbourtime per trip = 5 days
 2. Searching time = 4 days
 3. Fishing time = 10 days
- Total time excluding sailing to/from fishing grounds = 19 days

	outward sailing time	home sailing time	total sailing time	total sailing time		fishing activities	total trip	off operation per year	trips per year	2250	ton per year	ratio
miles:	14.0 knots	12.0 knots	hours	days		days	days	days	nr	ton	-	
125	9	10	19	0.8		19	19.8	10	17.9	40 329	100	
250	18	21	39	1.6		19	20.6	10	17.2	38 752	96	
500	36	42	77	3.2		19	22.2	10	16.0	35 941	89	
1000	71	83	155	6.4		19	25.4	10	13.9	31 387	78	
1200	86	100	186	7.7		19	26.7	10	13.3	29 873	74	
1400	100	117	217	9.0		19	28.0	10	12.7	28 499	71	

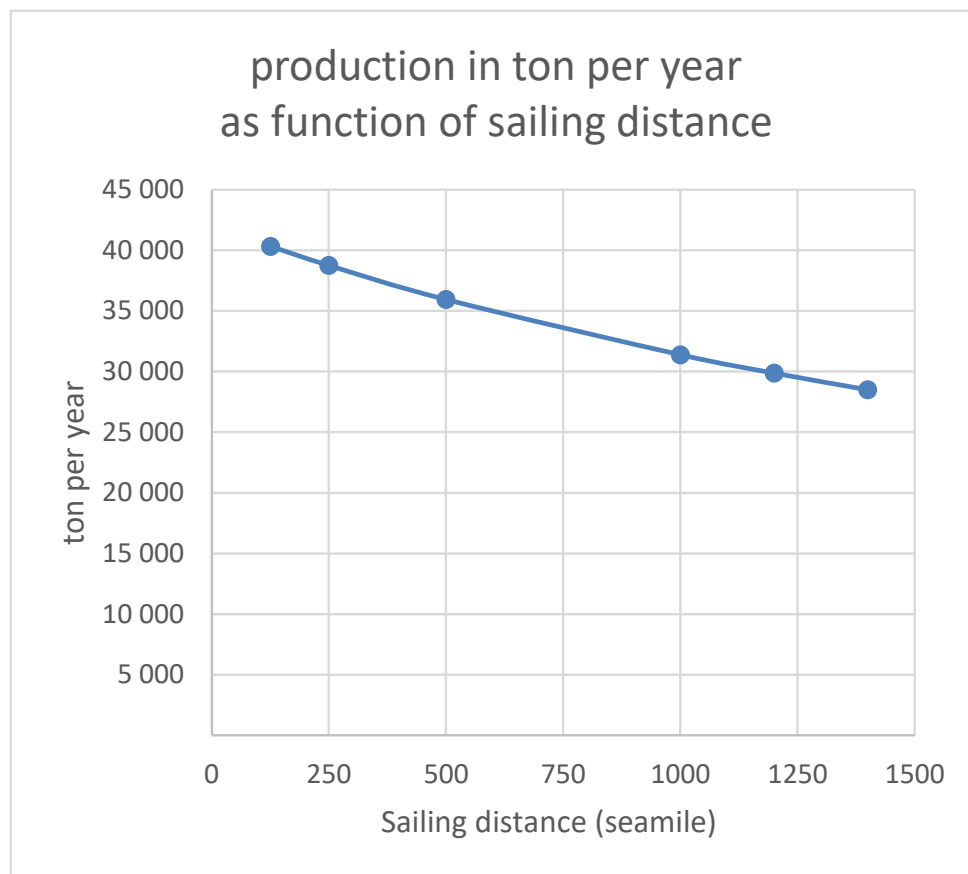

From this exercise we learn that the Fishing Capacity strongly depends on the sailing distance to the fishing grounds. In European circumstances it can make a difference of more than 25% whether fishing is performed in close distances of say 200 miles or larger distance of say 1200 miles.

11 Proposal for alternative formulation fishing capacity

11.1 EU status quo

The fishing capacity in the EU regulations is simply: 'fishing capacity' means a vessel's tonnage in GT (Gross Tonnage) and its power in kW (Kilowatt) as defined in Articles 4 and 5 of Council Regulation (EEC) No 2930/86 (2);

More specific the approach of the EU is described in the paper of Lindebo.³⁷

“Although fishing is an economic activity and fishing operations heavily depend on the economic outcome, the defining and measuring of fishing capacity in practice have excluded economic factors. Instead, fishing capacity has historically been estimated through the measurement of certain, relatively straightforward, physical characteristics of a fleet in order to give an indication of the maximum potential output.

These characteristics may include the number of vessels, vessel tonnage, engine power, hold size, vessel length and gear and fishing methods used. Other determining factors, that may be more difficult to define, include available fishing time, stock catchability and skill and knowledge of the skipper and crew (technical efficiency). The exact fishing capacity indicator used will depend on the characteristics of the fishery fleet and the availability of reliable data. For example it is generally accepted that for trawlers the single most important factor is engine power. For gill-netters, however, the engine effect would be of limited importance – it is more likely that vessel tonnage will determine fishing capacity, since the size of the vessel will largely determine the amount of gear and size of crew on board. Applying a universal capacity measure across a range of fisheries may therefore prove inadequate and has proven to be a stumbling block when addressing the issue of global fishing capacity measurement. Applied measurements procedures may therefore only be applicable on a fishery-by-fishery base, or at best, on a regional basis.”

“Fishing capacity in the EU has historically been measured in terms of two vessel characteristics, namely gross tonnage and engine power... The number of vessels, number of fishers, and catch and landing data have also been monitored but have not been incorporated as official indicators in capacity reduction initiatives.”

Comment: This is very strange, because the target should be to control the catches, not the GT and kW.

“New and existing vessels of less than 15 m in length, due to the lesser importance of superstructure volume of these vessels. $GT = (0.2 + 0.02 \log V)V$ where $V = L_{oa} \times B \times T$, where T = depth, B = breadth, L_{oa} = length over all.

Comment: This could be considered also for larger vessels, as it leaves free the superstructures including deckhouse and forecastle as important for comfort and safety. It could on the other hand lead to reduction of depth, which is not favourable for safety. Is displacement a suitable figure to be used as V? Or use $L \times B \times Draught$, this leaves the depth and the superstructures free.

³⁷ Lindebo, E., Fishing capacity and European union fleet adjustment.

11.2 FAO TWG

The following definition is used by the Technical Working Group of FAO on the Management of Fishing Capacity³⁸:

“Fishing capacity is the ability of a vessel or fleet of vessels to catch fish. Fishing capacity can be expressed more specifically as the *maximum amount of fish* over a period of time (year, season) that can be produced by a fishing fleet if fully utilized, given the biomass and age structure of the fish stock and the present state of technology”

“Alternatively fishing capacity can be expressed in reference to fleet characteristics or as the ability of the fleet to generate fishing effort. Economists use related concepts of capital stock (vessels) or capital services (fishing efforts). Aggregate proxies are typically used to measure the capital stock which the fleet represents, *e.g. gross registered tonnage or horse power*³⁹.”

The first definition is from a biological point of view, the alternative second definition is from an economical point of view.

What is apparently missing is the fishing capacity from a technical point of view. This will be dealt with in the second paragraph of this chapter.

The TWG further considers: “The major difficulty is to identify the combination of attributes that best reflects the productivity of relatively heterogeneous fishing units. An indicator can be developed by weighing key vessel attributes (e.g. length, breadth and power). Other attributes of importance will be gear type and key characteristics, as well as vessel age and embodied technical change.”

The TWG considered it for several reasons advantageous to formulate fishing capacity in terms of *catch* and *not* in terms of e.g. *gross tonnage and horsepower*.

The TWG further defined target capacity: “Target fishing capacity is the maximum amount of fish over a period of time (year, season) that can be produced by a fishing fleet if fully utilized while satisfying fishery management objectives designed to ensure sustainable fisheries.”

The TWG also discussed alternative approaches to estimating capacity output, *including hold capacity* and maximum number of fishing trips per year and two other methods, the peak-to-peak analysis and the Data Envelopment Analysis (DEA).

The peak-to-peak method determines capacity by the observed relationship between catch and fleet size over time. The DEA method is a mathematical programming method, which can estimate capacity under constraints including TAC's, by-catch, regional and/or size distribution of vessels, restrictions on fishing time, minimum employment levels.

The TWG in its report also summed up the following required information. “estimate of vessel numbers and the main vessel characteristics determining fishing power (e.g. GRT or GT, engine power, length, hold capacity, gear type and dimensions, with the importance of each of these varying depending on the fishery)); basic relevant characteristics of fishing operations (e.g. seasonality, number of fisheries in which vessels operate); landings; and at least a qualitative indication of trends in CPUE or other information that can give at least a rough index of MSY.”

³⁸ Pascoe, Greboval, Ed. Measuring capacity in fisheries. FAO Technical Paper nr 445. Rome, 2003.

³⁹ italics added

“Monitoring and assessment of capacity will require more specific data, such as:

- vessels: hold, engine power, engine efficiency, vessel size, fish finding equipment
- gear: type and size
- biological characteristics of stocks
- number of participants, skill levels
- cost and earnings surveys
- employment
- information on subsidies
- fishing operation relative to fish distributions
- reaction of fishing industry to management
- existence and adequacy of access controls”

Comment: this is very specific information to define/measure the catching potential. But this is simply not necessary when the TAC of this vessel is obeyed and controlled.

11.3 Iceland

In Icelandic fisheries⁴¹ in the past Gross Tonnage was used in relation to total catch. However, in the publication the following reservations are made:

- “size in GRT of new ships tend to be larger than in older ships due to demand for more spacious living quarters on board
- increasing trend to processing at sea needs more spacious ships
- technical improvements in fishing gear and electronic fish finding equipment increase the catch capacity of ships and this is not reflected in changes in size of ships”

It was observed that the size of the fleet increased in terms of GT, but that catches decreased in the same period.

Comment: This shows that GT has no influence on the catching potential.

11.4 Norway

In Norwegian pelagic fisheries a licence is rendered to a vessel for a certain cargo capacity, while the available TAC is assigned to the vessel based on a certain division formula as function of the size of the vessel.⁴² The quota of smaller vessels may be combined into larger vessels, thus improving economy of scale.

11.5 Electronic recording and reporting of fishing activities

Modern technology makes it very well possible that fishing activities can be accurately monitored, so that it can also be controlled if the TAC of the vessel is obeyed, with or without GT and/or kW limitations. Regulations also leave room for this approach.⁴³

⁴¹ Klemensson, O.O., The development and fund of the Icelandic Fisheries: objectives, activities and impacts. In: Overcapacity, Overcapitalization and Subsidies in European Fisheries. Proceedings workshop, Portsmouth 1998.

⁴² Asche, F. Quota regulation, rent and value of licenses in the Norwegian pelagic fisheries. Proceedings workshop, Portsmouth, 1998.

⁴³ EC 1966/2006 electronic recording and reporting of fishing activities on means of remote sensing

12 Summary and conclusion

12.1 On Gross Tonnage

Gross Tonnage limitation has a negative impact on safety, comfort and fish quality as it punishes initiatives to add extra safety, comfort and quality measures to ships as the involved extra cubic meters have to compete with e.g. hold volume, volume of engine room or fuel tanks.

12.2 On kiloWatts

Kilowatt limitation has a very weak rationale as:

- g. Very large variations can occur in the pulling power per kilowatt due to the specific design of up to 40%
- h. Very large variations can occur in the requested pulling power of nets due to the choice of twine materials and trawl doors of more than 50% for the same opening circumference
- i. Which means that a difference in kW can exist of close to 100% between two ships: one with a simple propeller and a conventional net and one with advanced twin propeller and advanced dynema net with high lift trawl doors
- j. Certain fishing métiers do not use the available power to even *avoid* large catches in one haul for quality reasons
- k. Certain fishing métiers do not use the available power to fish, but for safe and fast trips to the fishing area

12.3 On alternative formulations of fishing capacity

Alternative formulations to control the amount of catching power are:

- c. **In the first place:** fishing capacity is limited by maintaining and controlling the TAC
- d. Other means than the detrimental GT to get an impression of the size of a ship, some possibilities are:
 - i. gross tonnage based on the product of LxBxT: length x beam x draught, this leaves room for sufficient depth and superstructures (e.g. accommodation and forecastle)
 - ii. gross tonnage based on displacement, this also leaves free the superstructures